

# Structured Media™ Centers (SMC)

Cat. No. 47605/47608



PK-93104-10-00-0J

### WARNINGS

- **TO AVOID DEATH OR INJURY**, ensure that each opening is filled with a module and never push objects of any kind into this product through openings, as they may touch dangerous voltages.
- **TO AVOID DEATH OR INJURY**, never touch uninsulated wires or terminals unless the wiring has been disconnected at the network interface.
- Do not use this product near water—e.g., near a tub, wash basin, kitchen sink or laundry tub, in a wet basement, or near a swimming pool. Read and understand all instructions. Follow all warnings and instructions marked on the product.
- **SAVE THESE INSTRUCTIONS.**

### CAUTIONS

- Never install communications wiring or components during a lightning storm.
- Never install communications components in wet locations unless the components are designed specifically for use in wet locations.
- Use caution when installing or modifying communications wiring or components.
- All devices housed by the enclosure(s) must be UL Listed.
- Please refer to the UL Listed Household Fire/Burglary Alarm control panels installation instructions for compatibility.

### CAUTIONS

- When installing Security and/or Fire Alarm Systems care must be taken to comply with all national and local codes. Plastic ties and anchors or other means must be used to maintain separation of power limited, non-power limited, telco and coaxial circuits. Additionally, separation of circuits must be maintained at the point of entrance to the enclosure (no combination of circuits should enter the panel knockout). Minimum spacing between power limited, non-power limited, telco and coaxial circuits shall be 1/4 inch.

## INSTALLATION INSTRUCTIONS

ENGLISH

### DESCRIPTION

Leviton's Structured Media™ Centers (SMC) make running cable and managing media both simple and cost-effective. Designed to provide a central distribution point for all your home or small office technologies, the SMCs accommodate: networking, fax, internet, DSL and cable modems, multi-line telephones, security camera, coaxial cable, satellite video distribution, and more.

**NOTE:** Prior to installation, check the part list on pg. 2, to insure that all parts are included with your product.

### Tools needed to install your Media Enclosure:

- Slotted/Phillips Screwdriver/Power Drill
- Utility Knife

### INSTALLING YOUR SMC MEDIA ENCLOSURE

Leviton's Structured Media™ Centers are designed to be flush mounted on center between 16" (40.6 cm) wall studs, but they may also be surface mounted.

#### Step 1

Remove knockouts before mounting the enclosure into the wall. Use the supplied foam grommets with knockout openings to protect cables.

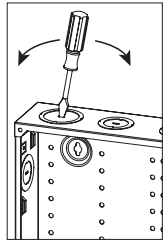

Knockout Removal

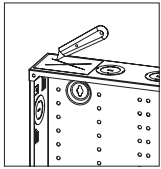

Grommet Placement

1. Place 1 foam grommet over each knockout.
2. With a utility knife, cut an "X" through each grommet.

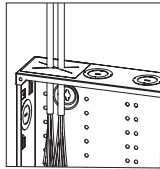

#### Step 2 Bending out tabs on SMC:

Leviton's Structured Media™ Centers offer a tab feature which can be used when the SMC is flush mounted on center between 16" (40.6 cm) wall studs.

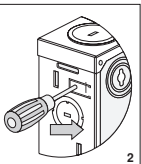
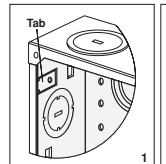

1. Insert screwdriver into tab hole from the out side of the SMC Center, as shown in diagram #2 on the left.
2. Push screwdriver right/left to bent out tab, as shown in diagram #3 on the left.
3. Place 1 foam grommet over each tab hole opening on the inside of the enclosure, as shown in diagram #4 on the left.

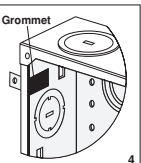
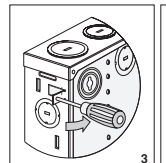

**CAUTION:** THE SMC IS A DISTRIBUTION DEVICE FOR LOW-VOLTAGE WIRING SYSTEMS. IT IS NOT DESIGNED TO BE USED AS AN AC POWER DISTRIBUTION PANEL.

#### Step 3 Mounting the SMC:

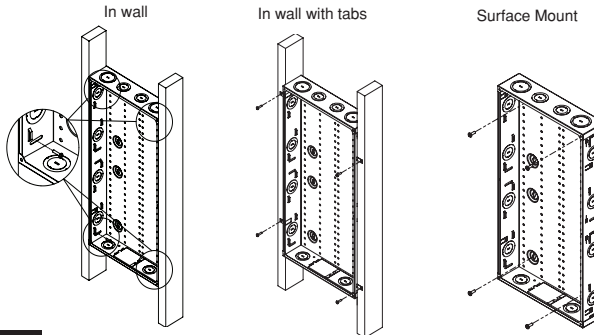

#### Step 4

Establish an appropriate ground wire between the grounding screw and the AC power ground point. A minimum of No. 10, solid conductor, bare copper wire is recommended to ground the unit.

**PROPER GROUNDING OF THE SMC IS AN ELECTRICAL SAFETY PRECAUTION. PROPER GROUNDING OF THE UNIT SHOULD BE VERIFIED BY AN ELECTRICIAN AND COMPLIANT WITH THE NATIONAL ELECTRICAL CODE.**

A cardboard Mud Guard has been provided with the packaging to protect the SMC enclosure during installation. Use it after the rough in phase to protect the SMC and wiring from dust and overspray until trim out.

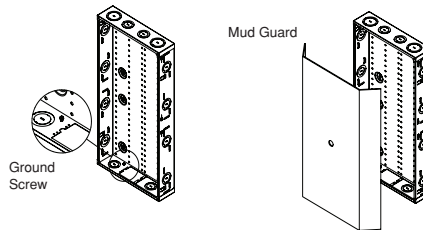

#### Step 5 Installing the SMC Cover:

Three options are available for Leviton's Structured Media Centers: the flush-mount cover, economy hinged door & premium hinged door. The hinged door offers an optional lock.

#### Flush-Mount Cover Installation

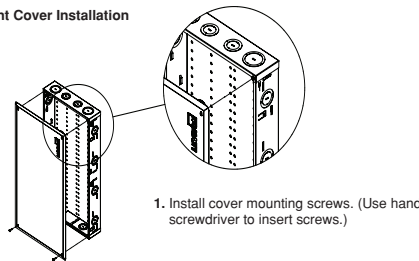

1. Install cover mounting screws. (Use hand screwdriver to insert screws.)

#### Step 5 Cont. Hinge Door Installation

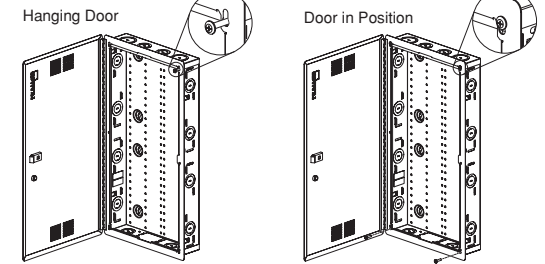

1. Attach top mounting screws to enclosure. Drive 1" mounting screws a min. of 1/4th inch using a hand screw driver. (Do not tighten all the way).
2. Hang door or cover using keyed holes onto enclosure.
3. Install remaining screws and tighten all screws to complete assembly (Torque spec: 4 in-lb).

#### NOTE:

Leviton recommends installing the optional lock prior to mounting the hinged door.

#### Optional Lock (PN# 5L000-LOK)

1. Remove the plastic plug from the SMC hinged door by pushing in the plug tabs with a screwdriver.
2. Insert lock tumbler (A) into the opening.
3. Screw on the nut (B) to secure the lock tumbler in the SMC.
4. Select the 90° limit washer (C) and install as shown.
5. Place the latch (D) on the back of the tumbler. Ensure latch step is towards the door.
6. **NOTE:** Make sure the latch (E) and the SMC frame edge tab overlap.
7. Insert and tighten the screw (E) into the back of the lock tumbler.
7. Check operation with supplied keys (F).

#### Outside Enclosure View

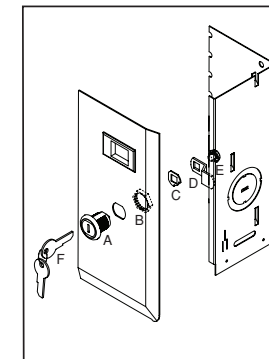

#### Inside Enclosure View

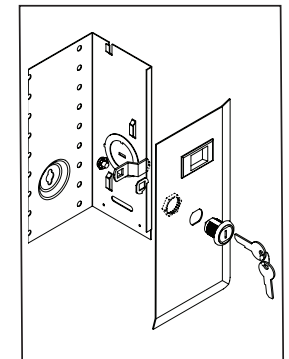

WEB VERSION

## 14" SERIES SMC AND ACCESSORIES

### 47605-140

#### Parts Included:

- (4) #10 x 1" wall mounting screws
- (4) #8-32 x 1" cover mounting screws
- (6) Self-healing foam grommets
- (1) Flush cover
- (1) Corrugated mud guard (Included with packaging supplied)

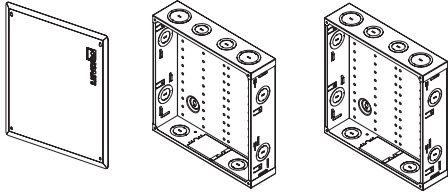

### 47605-14E

#### Parts Included:

- (4) #10 x 1" wall mounting screws
- (6) Self-healing foam grommets
- (1) Corrugated mud guard (Included with packaging supplied)

### 47605-14C

#### Parts Included:

- (4) #8-32 x 1" cover mounting screws

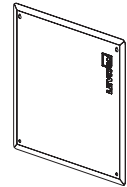

### 47605-14D

#### Parts Included:

- (4) #8-32 x 1" door mounting screws

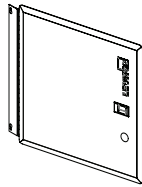

### 47605-14S

#### Parts Included:

- (4) #8-32 x 1" door mounting screws

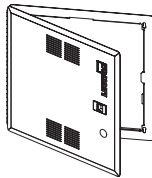

### 5L000-LOK

#### Parts Included:

- (1) Tumbler
- (1) Nut
- (1) Limit Washer
- (1) Latch
- (1) Latch screw
- (2) Keys

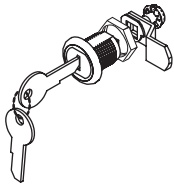

**Note:** 5L000-LOK may be used with 14", 21", 28", and 42" economy and premium hinged doors.

#### LIMITED 2 YEAR PRODUCT WARRANTY

For Leviton's limited 2 year product warranty, go to [www.leviton.com](http://www.leviton.com). For a printed copy of the warranty you may call 1-800-323-8920 or write to Leviton Manufacturing Co., Inc., Attn: Customer Service Dept., 201 North Service Road, Melville, New York 11747.

© 2021 Leviton Mfg. Co., Inc.

## 21" SERIES SMC AND ACCESSORIES

### 47605-21E

#### Parts Included:

- (4) #10 x 1" wall mounting screws
- (6) Self-healing foam grommets
- (1) Corrugated mud guard (Included with packaging supplied)

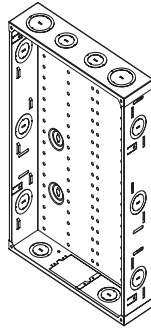

### 47605-21C

#### Parts Included:

- (4) #8-32 x 1" cover mounting screws



### 47605-21S

#### Parts Included:

- (4) #8-32 x 1" Philips door mounting screws
- (4) #8-32 x 1" Robertson door mounting screws

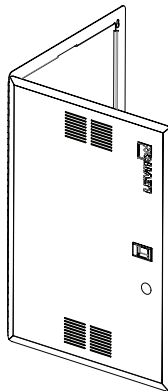

## 28" SERIES SMC AND ACCESSORIES

### 47605-28W

#### Parts Included:

- (4) #10 x 1" wall mounting screws
- (4) #8-32 x 1" cover mounting screws
- (6) Self-healing foam grommets
- (1) Flush cover
- (1) Corrugated mud guard (Included with packaging supplied)

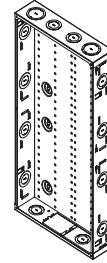

### 47605-F28

#### Parts Included:

- (4) #8-32 x 1" cover mounting screws



### 47612-28B

#### Optional 28" Extender Bracket

(For Reference Only)

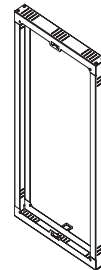

### 47605-28N

#### Parts Included:

- (4) #10 x 1" wall mounting screws
- (6) Self-healing foam grommets
- (1) Corrugated mud guard (Included with packaging supplied)

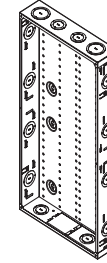

### 47605-28D

#### Parts Included:

- (4) #8-32 x 1" door mounting screws

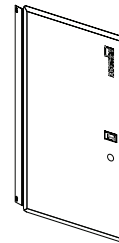

### 47605-28S

#### Parts Included:

- (4) #8-32 x 1" door mounting screws

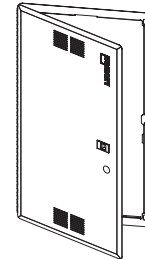

## 42" SERIES SMC AND ACCESSORIES

### 47605-42W

#### Parts Included:

- (6) #10 x 1" wall mounting screws
- (6) #8-32 x 1" cover mounting screws
- (6) Self-healing foam grommets
- (1) Flush cover
- (1) Corrugated mud guard (Included with packaging supplied)

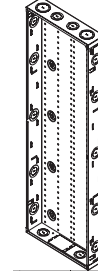

### 47605-F42

#### Parts Included:

- (6) #8-32 x 1" cover mounting screws



### 47612-42B

#### Optional 42" Extender Bracket

(For Reference Only)

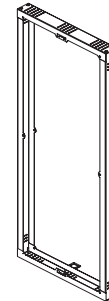

### 47605-42N

#### Parts Included:

- (6) #10 x 1" wall mounting screws
- (6) Self-healing foam grommets
- (1) Corrugated mud guard (Included with packaging supplied)

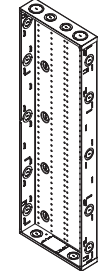

### 47605-42S

#### Parts Included:

- (6) #8-32 x 1" door mounting screws

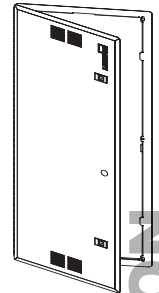

WEB VERSION