

Single Pole (One location) or 3-Way (Multi-location) Incandescent Dimmer

Cat. No. VZI06-1L, 600W (Lighted)
120VAC, 60Hz

INSTALLATION INSTRUCTIONS

WARNINGS AND CAUTIONS:

- To be installed and/or used in accordance with appropriate electrical codes and regulations.
- If you are unsure about any part of these instructions, consult a qualified electrician.
- To avoid overheating and possible damage to this device and other equipment, do not install to control a receptacle, fluorescent lighting, a motor- or a transformer-operated appliance.
- Use with incandescent or 120V halogen fixtures only.
- Vizia™ dimmers are not compatible with standard 3-way or 4-way switches. They must be used with compatible Vizia™ remotes for multi-location dimming.
- Use only one (1) Vizia™ dimmer in a multi-location circuit with up to 9 coordinating remotes without LEDs or up to 4 matching remotes with LEDs. The remote(s) will turn the light on at the brightness level selected at the dimmer.

WARNINGS AND CAUTIONS:

- Dimmer may not operate with dioded lamps (Sylvania Designer 16™ or Philips PAR-16™).
- Total minimum load must exceed 40W.
- Dimmer may feel warm to the touch during normal operation.
- Recommended minimum wall box depth is 2-1/2".
- Maximum wire length from dimmer to all installed remotes cannot exceed 300 ft.
- Disconnect power at circuit breaker or fuse when servicing, installing or removing fixture.
- Use this device only with copper or copper clad wire. With aluminum wire use only devices marked CO/ALR or CU/AL.

Tools needed to install your Dimmer

Slotted/Phillips Screwdriver Electrical Tape
Pencil Cutters
Pliers Ruler

Changing the color of your Dimmer:

If a color change kit is provided with your device and a color change is desired, proceed with the following step. Otherwise, proceed to "Installing Dimmer by itself or with other devices" section. To change color of your device proceed as follows:

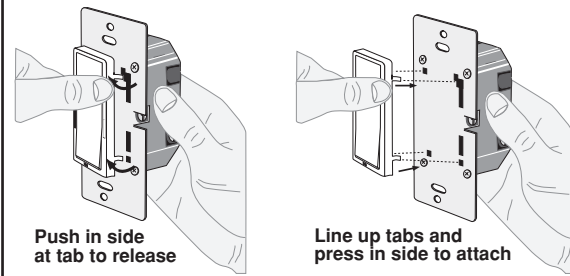

Installing Dimmer by itself or with other devices

If installing Dimmer in a single device application, proceed with the **INSTALLING YOUR DIMMER** section. If installing Dimmer in a multi-device application, proceed as follows:

MULTI-DEVICE APPLICATION:

In multi-dimmer installations, the reduction of the dimmer's capacity is required. Refer to the chart for maximum load per dimmer.

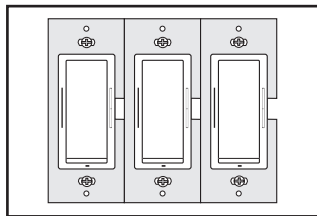

MAXIMUM LOAD PER DIMMER FOR MULTI-DEVICE			
Cat. No.	Single	Two Devices	More than 2 Devices
VZI06	600W	500W	400W

INSTALLING YOUR DIMMER

NOTE: Use check boxes when Steps are completed.

Step 1 **WARNING: TO AVOID FIRE, SHOCK, OR DEATH; TURN OFF POWER** at circuit breaker or fuse and test that power is off before wiring!



Step 2 **Identifying your wiring application (most common):**

NOTE: If the wiring in the wall box does not resemble any of these configurations, consult a qualified electrician.

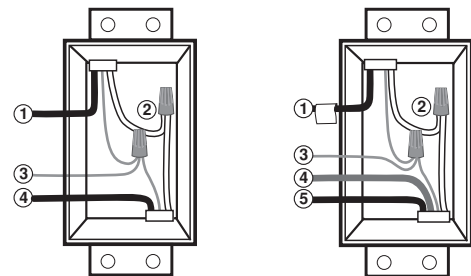

Single-Pole

- Line (Hot)
- Neutral
- Ground
- Load

3-Way

- Line or Load (See important instruction below)
- Neutral
- Ground
- First Traveler – note color
- Second Traveler – note color

NOTE: For matching remote w/LEDs installation, the **First Traveler** becomes Line Hot.

IMPORTANT: For 3-Way applications, note that one of the screw terminals from the old switch being removed will usually be a different color (Black) or labeled Common. Tag that wire with electrical tape and identify as the common (Line or Load) in both the dimmer wall box and remote wall box.

Step 3 Preparing and connecting wires:

This dimmer can be wired using side wire terminal screws or through backwire openings. Choose appropriate wire stripping specifications accordingly.

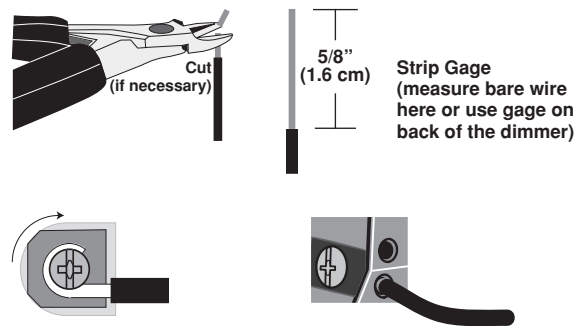

Side Wire Connection

Side wire terminals accept #14 AWG solid copper wire only.

Back Wire (either hole may be used)

Back wire openings use #14-12 AWG solid copper wire only.

- Make sure that the ends of the wires from the wall box are **straight (cut if necessary)**.
- Remove insulation from each wire in the wall box as shown.
- For Single-Pole Application, go to Step 4a.**
- For 3-Way Coordinating Remote (no LEDs) Application, go to Step 4b.**
- For 3-Way Matching Remote (with LEDs) Application, go to Step 4c.**

Step 4a Single-Pole Wiring Application:

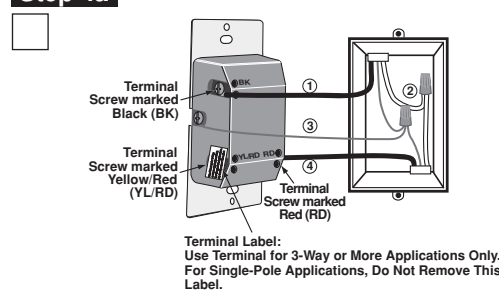

Step 4a cont'd

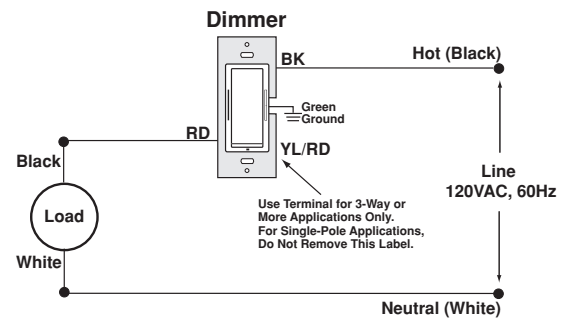

WIRING DIMMER:

Connect wires per **WIRING DIAGRAM** as follows:

- Green or bare copper wire in wall box to Green terminal screw.
 - Line Hot wall box wire to terminal screw marked "BK".
 - Load wall box wire to terminal screw marked "RD".
 - Dimmer terminal screw marked "YL/RD" should have Red insulation label affixed.
- NOTE:** If insulating label is not affixed to terminal screw marked "YL/RD", use electrical tape to cover.
- Proceed to Step 5.**

Step 4b 3-Way Wiring with Coordinating Dimming or Switching Remote (no LEDs) Application:

(Coordinating Dimming Remote Depicted)

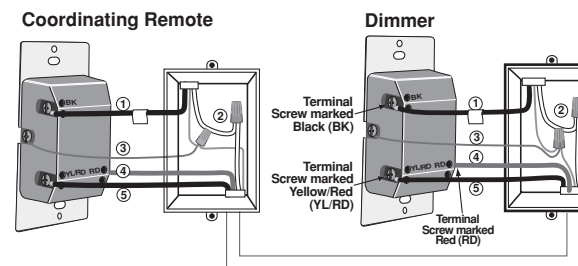

Step 4b cont'd

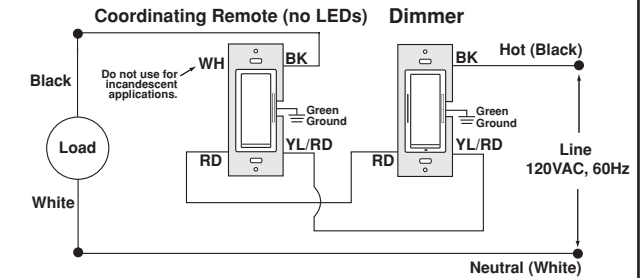

WIRING DIMMER:

Connect wires per **WIRING DIAGRAM** as follows:

NOTE: When using the coordinating remote without LEDs, the dimmer can be installed on either the Line or Load side of the 3-way circuit.

NOTE: Maximum wire length from dimmer to all installed remotes cannot exceed 300 ft.

- Green or bare copper wire in wall box to Green terminal screw.
- Line Hot (common) wall box wire identified (tagged) when removing old switch to terminal screw marked "BK".
- First Traveler wall box wire to terminal screw marked "RD" (**note wire color**). This traveler from the dimmer must go to the terminal screw on the remote marked "RD".
- Remove Red insulating label from terminal screw marked "YL/RD".
- Second Traveler wall box wire to terminal screw marked "YL/RD" (**note wire color**). This traveler from the remote must go to the terminal screw on the remote marked "YL/RD".

WIRING COORDINATING REMOTE:

Connect wires per **WIRING DIAGRAM** as follows:

NOTE: Maximum wire length from dimmer to last remote is 300ft.

- Green or bare copper wire in wall box to Green terminal screw.
 - Load wall box wire identified (tagged) when removing old switch to terminal screw marked "BK".
 - First Traveler wall box wire (**note color as above**) to terminal screw marked "RD". This traveler from the remote must go to the terminal screw on the dimmer marked "RD".
 - Second Traveler wall box wire (**note color as above**) to terminal screw marked "YL/RD". This traveler from the remote must go to the terminal screw on the dimmer marked "YL/RD".
 - Remote terminal screw marked "WH" should have White insulation label affixed.
- NOTE:** If insulating label is not affixed to terminal screw marked "WH", use electrical tape to cover.
- Proceed to Step 5.**

Step 4c 3-Way Wiring with Matching Remote (w/LEDs) Application:

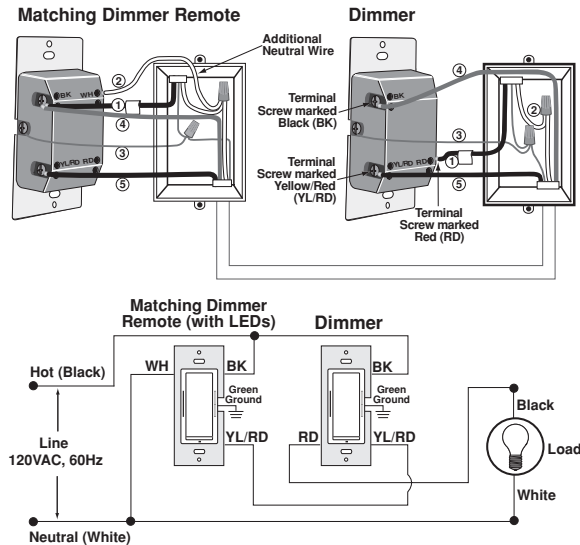

NOTE: The dimmer **must** be installed in a wall box that has a Load connection. The matching remote **must** be installed in a wall box with a Line Hot connection and a Neutral connection. A Neutral wire to the matching remote needs to be added as shown.

If you are unsure about any part of these instructions, consult a qualified electrician.

NOTE: Maximum wire length from dimmer to all installed remotes cannot exceed 300 ft.

WIRING MATCHING REMOTE (wall box with Line Hot connection):

Connect wires per WIRING DIAGRAM as follows:

- Green or bare copper wire in wall box to Green terminal screw.
- Line Hot (common) wall box wire identified (tagged) when removing old switch and First Traveler to dimmer terminal screw marked "BK".
- Second Traveler wall box wire from dimmer to remote terminal screw marked "YL/RD" (**note wire color**). This traveler from the remote must go to the terminal screw on the dimmer marked "YL/RD".
- Line Neutral wall box to remote terminal screw marked "WH".

WIRING DIMMER (wall box with Load connection):

Connect wires per WIRING DIAGRAM as follows:

- Green or bare copper wire in wall box to Green terminal screw.
- Load wall box wire identified (tagged) when removing old switch to dimmer terminal screw marked "RD".
- First Traveler Line Hot to dimmer terminal screw marked "BK".
- Remove Red insulating label from terminal screw marked "YL/RD".
- Second Traveler wall box wire (**note color as above**) to dimmer terminal screw marked "YL/RD". This traveler from the dimmer must go to the terminal screw on the remote marked "YL/RD".
- Proceed to Step 5.**

Step 5 Testing your Dimmer prior to mounting in wall box:

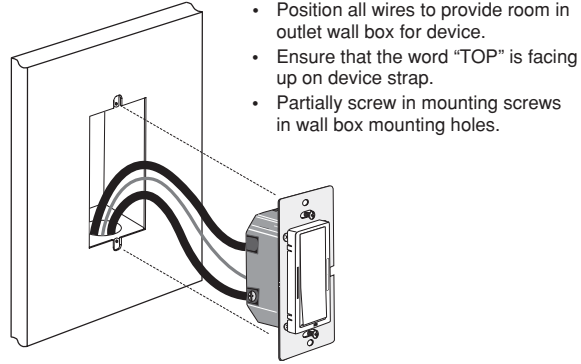

NOTE: Dress wires with a bend as shown in diagram in order to relieve stress when mounting device.

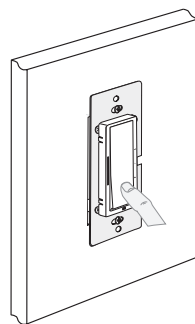

- Restore power at circuit breaker or fuse.
- Press pad until locator light is OFF. Lights should turn ON. If lights do not turn ON, press the upper half of DIM/BRIGHT bar until the lights brighten.

If lights still do not turn ON, refer to the TROUBLESHOOTING section.

Step 6 Dimmer Mounting: TURN OFF POWER AT CIRCUIT BREAKER OR FUSE.

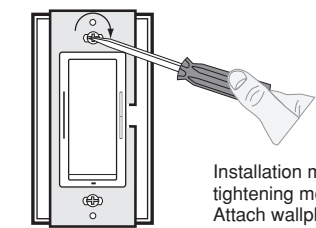

Installation may now be completed by tightening mounting screws into wall box. Attach wallplate.

Step 7 Restore Power: Restore power at circuit breaker or fuse. Installation is complete.

OPERATION

NOTE: The locator light will illuminate when the load is in the OFF position to facilitate access to the device.

NOTE: If using the dimmer in a 3-way application, the lights will turn ON at brightness set on dimmer's DIM/BRIGHT bar. The lighting can be controlled from either the dimmer or the remote location.

Push Pad (Default settings)

Turn ON from OFF position:

Tap – Lights turn ON to preset level.
Press and Hold – Lights turn ON to full bright.

Turn OFF from ON position:

Tap – Lights turn OFF.

DIM/BRIGHT Bar

BRIGHTEN:
Press upper half of DIM/BRIGHT Bar – Lights brighten to desired level.

DIM:
Press lower half of DIM/BRIGHT Bar – Lights dim to desired level.

If you continue to hold the lower half of the DIM/BRIGHT Bar, the lights will DIM to minimum level and then turn OFF.

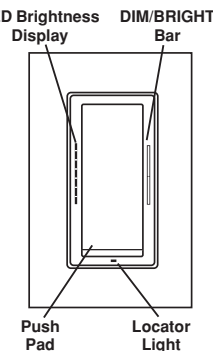

NOTE: When lights are OFF you can change the light level that the lights will turn ON to using the DIM/BRIGHT Bar.

If there is a power outage, when the power is restored the lights will return to the last setting before the power interruption.

Air-Gap Switch: On the dimmer only, engage the air-gap switch by gently pulling the bottom of the push pad until it lifts completely out of the frame and a click is heard and all LED's are OFF (**refer to Figure**). This will cut power to the fixture to replace the bulb. After servicing is complete, push the push pad back for normal operation.

Cleaning: Clean with a damp cloth. **DO NOT** use chemical cleaners.

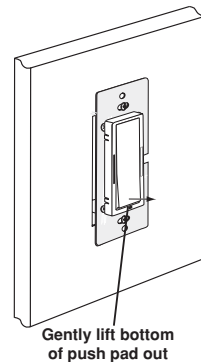

ADVANCED PROGRAMMING FEATURES

Mode 1 – Set Minimum Brightness: Set the minimum brightness level that the lights can dim to prior to turning full OFF.

Mode 2 – Set Dim-Lock: Set the brightness level that the lights will turn on to regardless of the previous light level at which they were turned OFF.

Mode 3 – Set Fade Rate: Set the amount of time (in seconds) that the lights will have to turn ON or OFF. Fade rates can be set to one of 7 different settings.

Advanced Features Summary			
Mode	Description	Range	Default
1	Set Min. Brightness	1-50%	25%
2	Set Dim-Lock Level	0-100%, 0=no lock	0
3	Select Fade Rate	1, 2, 3, 4, 5, 6 or 7	Preset #1

To Program:

NOTE: Have a flashlight handy if this dimmer controls the only light source in the room.

1. On the dimmer only, engage the air-gap switch by gently pulling the bottom of the push pad until it lifts completely out of the frame and a click is heard and all LED's are OFF.

2. Press push pad back into frame and hold push pad for 7 seconds until the locator light and the top LED (LED 1) starts blinking.

3. Upon releasing the push pad, the locator light will continue to blink once per second indicating the dimmer is in Mode 1, Set Minimum Brightness mode. To change the current Minimum Brightness level from 1-50%, use the DIM/BRIGHT Bar. This setting will automatically be saved.

4. Tap the push pad to change to Mode 2, Set Dim-Lock Level mode. The locator light will blink twice per second. To change the current Set Dim-Lock level from 1-100%, use the DIM/BRIGHT Bar. If this feature is not desired, press and hold the lower half of the DIM/BRIGHT Bar until no LED is lit. This setting will automatically be saved.

5. Tap the push pad to change to Mode 3, Set Fade Rate mode. The locator light will blink 3 times per second. To change the current Fade Rate, use the DIM/BRIGHT Bar to move the LED to the desired preset level. This setting will automatically be saved by tapping the push pad to exit programming mode.

The LED Brightness Display is separated into 7 segments. Each LED represents a preset level with LED 1 (Preset 1) located at the top and LED 7 (Preset 7) located at the bottom. Refer to chart for settings and defaults.

NOTE: The dimmer will exit program mode after 3 minutes of inactivity.

Fade Rate Presets			
Preset	LED**	Fade On	Fade Off
1*	1	Approx. 1.5s from full off	Approx. 3s from full on
2	2	No Fade	No Fade
3	3	No Fade	Approx. 3s from full on
4	4	Approx. 0.5s from full off	Approx. 3s from full on
5	5	Approx. 0.5s from full off	Approx. 1.5s from full on
6	6	Approx. 1.5s from full off	Approx. 5s from full on
7	7	Approx. 1.5s from full off	Approx. 10s from full on

* default

** LED #1 is located at the top

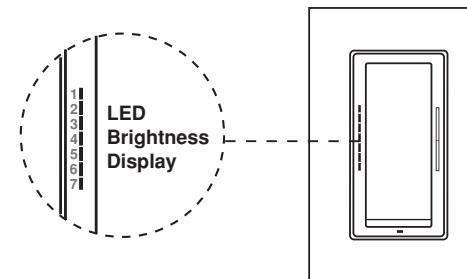

TROUBLESHOOTING

- Lights Flickering**
 - Lamp has a bad connection.
 - Wires not secured firmly under terminal screws of dimmer and/or remote.
- Light does not turn ON and Locator LED does not turn ON**
 - Circuit breaker or fuse has tripped.
 - Lamp is burned out.
 - Lamp Neutral connection is not wired.
- Intermittent dimmer operation**
 - Minimum load is under 40W.
- Remote does not operate lights**
 - Ensure that total wire length does not exceed 300 ft.

For additional information, contact Leviton's Techline at 1-800-824-3005 or visit Leviton's website at www.leviton.com

Covered by one or more US & Foreign Patents and patents pending
Copyright © 2006 Leviton Manufacturing Co., Inc.
All Rights Including Trade Dress Rights Reserved

FCC COMPLIANCE STATEMENT

This equipment has been tested and found to comply with the limits for a Class B Digital Device, pursuant to Part 15 of the FCC Rules. These limits are designed to provide reasonable protection against harmful interference in a residential installation. This equipment generates, uses, and can radiate radio frequency energy and, if not installed and used in accordance with the instructions, may cause harmful interference to radio communications. However, there is no guarantee that interference will not occur in a particular installation. If this equipment does cause harmful interference to radio or television reception, which can be determined by turning the equipment OFF and ON, the user is encouraged to try to correct the interference by one or more of the following measures:

- Reorient or relocate the receiving Antenna.
- Increase the separation between the equipment and the receiver.
- Connect the equipment into an outlet on a circuit different from that to which the receiver is connected.
- Consult the dealer or an experienced radio/tv technician for help.