

## Hi-Fi™ 2 4x4

### User Guide

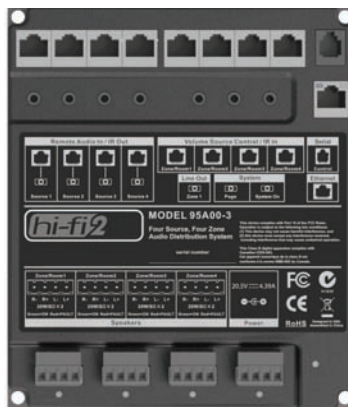

### Four Zone - Four Source Digital Audio Distribution System



## FEATURES - Hi-Fi™ 2 4x4 SYSTEM

- Includes 4 audio source inputs and 4 amplified audio zones
- Super efficient digital amplification with 40-watts per zone
- Includes universal power supply
- Includes 4 VSC keypads with graphical display
- Includes 2 Remote Input Modules (RIM) with IR output
- Includes IR Remote Control
- Equipped with a variable output for additional amplification
- Includes a serial port and Ethernet port for control



## WARNINGS AND CAUTIONS

- **WARNING: TO AVOID DEATH OR SERIOUS PERSONAL INJURY** never push objects of any kind into this product through openings, as they may touch dangerous voltages.
- **WARNING: TO AVOID DEATH OR SERIOUS PERSONAL INJURY** never touch uninsulated wires or terminals unless the wiring has been disconnected at the network interface.
- Read and understand all instructions. Follow all warnings and instructions marked on the product.
- Do not use this product near water - e.g., near a tub, wash basin, kitchen sink or laundry tub, in a wet basement, or near a swimming pool.
- Never install communications wiring or components during a lightning storm.
- Never install communications components in wet locations unless the components are designed specifically for use in wet locations.
- Use caution when installing or modifying communications wiring or components.
- **SAVE THESE INSTRUCTIONS.**

# CONTENTS

<b>Precautions</b> .....	<b>1</b>
<b>IMPORTANT SAFETY INSTRUCTIONS:</b> .....	<b>1</b>
<b>Introduction</b> .....	<b>2</b>
<b>GENERAL</b> .....	<b>2</b>
<b>Operation</b> .....	<b>3</b>
<b>ZONE ON/OFF</b> .....	<b>3</b>
<b>ALL ZONES OFF</b> .....	<b>3</b>
<b>SETTING ZONE VOLUME</b> .....	<b>3</b>
<b>SOURCE SELECTION</b> .....	<b>4</b>
<b>TRANSPORT CONTROLS</b> .....	<b>4</b>
<b>ZONE MENU</b> .....	<b>4</b>
Setting Zone Balance Level .....	5
Setting Zone Bass Level .....	5
Setting Zone Treble Level .....	5
Setting Zone Loudness .....	5
Setting the Brightness .....	6
Initial Volume Setting .....	6
Page Volume Setting .....	6
<b>ADVANCED MENU</b> .....	<b>7</b>
Setting the Audio Zone .....	8
Source Connection Status Settings .....	8
Source Gain Settings .....	8
IR Passthrough .....	8
IR .....	9
<b>IR FEATURES</b> .....	<b>9</b>
Locally Processed IR .....	9
Using the IR Remote Control .....	10
IR Passthrough .....	10
IR Output .....	10
<b>Connecting Your Music Source</b> .....	<b>11</b>
<b>Page / Mute</b> .....	<b>12</b>
<b>Zone Grouping</b> .....	<b>12</b>

## Precautions

Exposure to extremely high noise levels may cause a permanent hearing loss. Individuals vary considerably to noise induced hearing loss but nearly everyone will lose some hearing if exposed to sufficiently intense noise for a sufficient time. The U.S. Government's Occupational Safety and Health Administration (OSHA) has specified the following permissible noise level exposures:

DURATION PER DAY (HOURS)	8	6	4	3	2	1
SOUND LEVEL (dB)	90	93	95	97	100	103

According to OSHA, any exposure in the above permissible limits could result in some hearing loss.

## Important Safety Instructions:

1. Read all safety and operating instructions before using this product.
2. All safety and operating instructions should be kept for future reference.
3. Read and understand all warnings listed on the operating instructions.
4. Follow all operating instructions to operate this product.
5. This product should not be used near water (.e. bathtub, sink, swimming pool, wet basement, etc.).
6. Only use dry cloth to clean this product.
7. Do not block any ventilation openings.
8. Do not install this product near any heat sources; such as, radiators, heat registers, stove or other apparatus (including heat producing amplifiers) that produce heat.
9. Do not defeat the safety purpose of the polarized or grounding type plug. A polarized plug has two blades with one wider than the other. The wide blade is provided for your safety. If the provided plug does not fit into your outlet, consult an electrician for replacement.
10. Protect the power cord being walked on or pinched, particularly at plugs, convenience receptacles and the point where they exit from the apparatus.
11. Only use attachments specified by the manufacturer.
12. Use only with the cart, stand, tripod, bracket, or table specified by the manufacturer or sold with the apparatus. When a cart is used, use caution when moving cart/apparatus combination to avoid injury from tip-over.
13. Unplug this apparatus during lightning storms or when unused for long periods of time.
14. Care should be taken so that objects do not fall and liquids are not spilled into the unit through the ventilation ports or any other openings.
15. Refer all servicing to qualified service personnel. Servicing is required when the apparatus has been damaged in any way; such as, a liquid has been spilled or objects have fallen into the apparatus, the apparatus has been exposed to rain or moisture, does not operate normally or has been dropped.
16. **WARNING:** To reduce the risk of fire or electric shock, do not expose this apparatus to rain or moisture.

## Introduction

Thank you for purchasing your new Hi-Fi™ 2 4x4 audio distribution system. You are about to enjoy the freedom and convenience of listening to and sharing music from your stereo, iPod™, satellite radio, digital cable TV, computer, CD player, or any other music source in any room in your home.

*Hi-Fi 2 4x4* is a Four Zone, Four Source audio distribution system that powers speakers through digital amplification.

## General

Each of the four possible audio sources is connected directly to Remote Input Modules (RIM) in rooms that will have music sources that you wish to use. When you plug any music source into a RIM using a standard stereo input jack, it can be shared with any room that has a Volume-Source Control (VSC). Additionally, each RIM features a routed IR emitter jack and includes a flasher to allow you to use the remote control of your source equipment in any room that has a VSC.

The audio sources can be selected and controlled by any VSC. The VSC provides the ability to change the power state, volume setting, balance setting, treble setting, bass setting, and loudness setting for the respective audio zone. The brightness of the display and the initial volume setting and paging volume settings for each audio zone can also be configured.

The VSC allows you to view metadata feedback (album, artist, and track) and allows for basic transport controls (play, pause, next track, and previous track) for supported sources. Additionally, each VSC includes an IR receiver that allows you to remotely control the *Hi-Fi 2 4x4* system and/or audio sources from any audio zone in the house.

You can also use the VSC to control advanced features of *Hi-Fi 2 4x4*. Using the Advanced Menu, you can set the connection status and source gain for each source, whether IR is enabled or disabled, and whether IR is passed to the connected audio sources.

Furthermore, the *Hi-Fi 2 4x4* can plug and play with LEVITON Omni™ and Lumina™ home control systems. When connected, the LEVITON controller can set the source and volume of each audio zone for parties, watching TV, morning news, or any other activity. Any changes made to the power state, volume, or source at a VSC will be updated on the LEVITON controller and displayed on an LEVITON OmniTouch™ touchscreen.

## Operation

When an audio zone is turned on and the Volume-Source Control (VSC) in that zone is idle, the display will show the current source in the respective audio zone on the top line. When connected to a supported source that provides metadata, the bottom line will display the artist, album, and/or track.

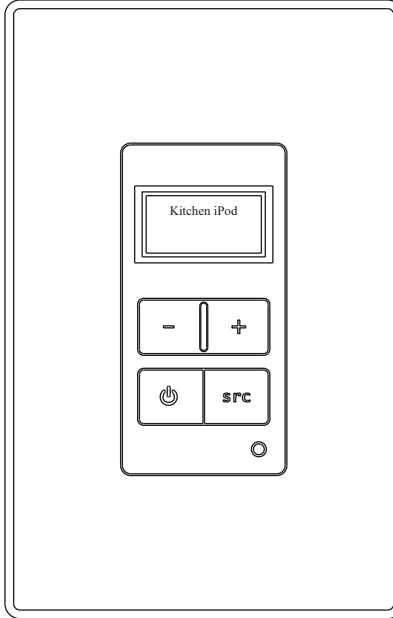

### Zone On/Off

The **Power** button is used to turn the respective audio zone on and off. When the audio zone is off, the display on the respective VSC is blank. To turn the audio zone on, press the **Power** button. The display will show the current audio source and the volume will be set to the configured Initial Volume for the respective audio zone. To turn the audio zone off, press the **Power** button.

### All Zones Off

If you wish to turn all audio zones off, press the **Power** button and hold it for 2 seconds. All audio zones on the Hi-Fi™ 2 4x4 system are turned off.

### Setting Zone Volume

Press the Volume **+** button to increase the volume in the respective audio zone. Press the Volume **-** button to decrease the volume in the respective audio zone. While the volume is being adjusted, the display on the VSC will show a volume bar with the current volume represented on the bar.

If the audio zone is currently muted, adjusting the volume using either the Volume **+** or Volume **-** buttons turns mute off and audio is heard at the current volume setting.



## Source Selection

To change the audio source in a zone, press **src** (source) button to cycle through all available audio sources. Each time the button is pressed and then released, the next available source is displayed. If a particular source is not connected, it will not be displayed and you will not have the option of connecting the VSC to that source. Once the last source is reached, pressing again will bring you back to the first source connected to the system.



## Transport Controls

The VSC allows you to issue basic transport control commands (play, pause, next track, and previous track) on supported audio sources. When connected to a supported audio source, you can issue these transport control commands using button combinations. Pressing and holding the **src** button acts as a function key that transforms the functions of the **+**, **-**, and **Power** buttons, as follows:

Press and hold the <b>src</b> button, then press:	<b>+</b> button	➤	play the next track
Press and hold the <b>src</b> button, then press:	<b>-</b> button	➤	play the previous track
Press and hold the <b>src</b> button, then press:	<b>Power</b> button	➤	toggle between play and pause

## Zone Menu

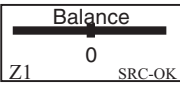
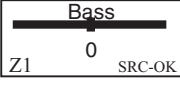
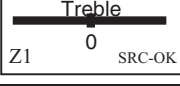
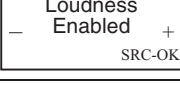
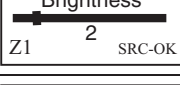
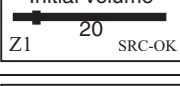
The Zone Menu is used to adjust the balance, bass, treble, loudness settings, initial volume, and paging volume for an audio zone and brightness of the display. To access the Zone Menu, simultaneously press and hold the Volume **+** and Volume **-** buttons.

Display	System Setting	Default Value	Range
	Balance	0	-10 to 10
	Bass	0	-10 to 10
	Treble	0	-10 to 10
	Loudness	Enabled	Press <b>-</b> to disable Press <b>+</b> to enable
	Brightness	2	1 to 5
	Initial Volume	20	0 – Resume last volume 2 to 100
	Page Volume	40	0 to 100

If there is no interaction with the VSC for more than 20 seconds, the menu will be exited and the display will revert back to the source setting. You can also manually exit from the Zone Menu by pressing and holding the **src** button for 2 seconds.

- Press and release the **src** button to advance to the next menu item.
- Press the **Power** button to go back to the previous menu item.
- Press the + button to adjust the current item.
- Press the – button to adjust the current item.

### **Setting Zone Balance Level**

The Balance setting allows you to change the balance levels for the left and right speakers in the respective audio zone. To change the balance level setting, press the + button (1 to 10) to attenuate the left channel. Press the – button (-1 to -10) to attenuate the right channel.

After modifying the Balance setting, press and release the **src** button to advance to the Bass menu item.

### **Setting Zone Bass Level**

The Bass setting allows you to change the bass level for the respective audio zone. To change the bass level setting, press the + button (1 to 10) to increase the bass level and press the – button (-1 to -10) to decrease the bass level. The bass level can range from -10 to 10.

After modifying the Bass setting, press and release the **src** button to advance to the Treble menu item.

### **Setting Zone Treble Level**

The Treble setting allows you to change the treble level for the respective audio zone. To change the treble level setting, press the + button (1 to 10) to increase the treble level and press the – button (-1 to -10) to decrease the treble level. The treble level can range from -10 to 10.

After modifying the Treble setting, press and release the **src** button to advance to the Loudness menu item.

### **Setting Zone Loudness**

The Loudness setting allows you to increase or decrease the intensity of the audio output for the respective audio zone. To change the loudness level setting, press the + button to enable the loudness level and press the – button to disable the loudness level.

After modifying the Loudness setting, press and release the **src** button to advance to the Brightness menu item.

## Setting the Brightness

The Brightness setting allows you to increase or decrease the brightness level of the display. To change the brightness level setting, press the **+** button to increase the brightness level and press the **-** button to decrease the brightness level of the display. The brightness level can range from 1 to 5.

After modifying the Brightness setting, press and release the **src** button to advance to the Initial Volume menu item.

## Initial Volume Setting

The Initial Volume setting allows you to set the starting volume level whenever the respective audio zone is turned on. To change the initial volume setting, press the **+** button to increase the initial volume setting and press the **-** button to decrease the initial volume setting.

To have the initial volume start at the volume that the respective audio zone was set to when it was last turned off, set the initial volume to “0”. This essentially allows you to use the **Power** button on the VSC as a mute function to quickly silence the audio zone. Then, when the audio zone is turned back on, the volume will resume at its previous level.

After modifying the Initial Volume setting, press and release the **src** button to advance to the Page Volume menu item.

## Page Volume Setting

The Page Volume setting allows you to set the paging volume for the respective audio zone. Thus, when the Page input is activated, Source 4 will act as the paging input source and the audio will be transmitted at this volume setting. To change the page volume setting, press the **+** button to increase the page volume setting and press the **-** button to decrease the page volume setting.

A setting of “0” means that the respective audio zone will be muted when the Page input is activated. This setting must be performed at the VSC in each audio zone and is applicable to that particular zone.

After modifying the Page Volume setting, press and release the **src** button to exit the menu. The display will revert back to the source setting.

## Advanced Menu

The Advanced Menu is used to set the audio zone for the VSC, to adjust the connection status and source gain for each source, whether IR is passed to the audio sources, and whether IR is enabled or disabled. To access the Advanced Menu, with the VSC turned off, press and hold the **src** button for 2 seconds. The respective audio zone will turn on and you will be able to adjust the following settings.

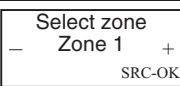
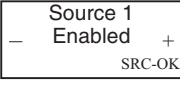
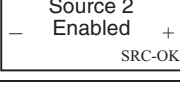
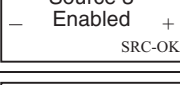
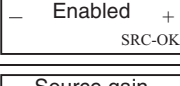
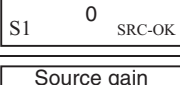
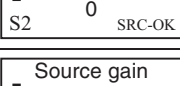
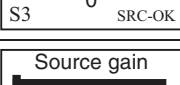
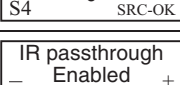
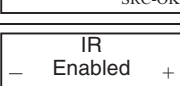
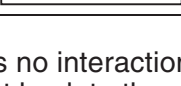
Display	System Setting	Default Value	Range
	Zone Setting for VSC	Zone 1	1 to 4
	Source 1 Connection Status	Enabled	Press - to disable Press + to enable
	Source 2 Connection Status	Enabled	Press - to disable Press + to enable
	Source 3 Connection Status	Enabled	Press - to disable Press + to enable
	Source 4 Connection Status	Enabled	Press - to disable Press + to enable
	Source 1 Gain	0	0 to 10
	Source 2 Gain	0	0 to 10
	Source 3 Gain	0	0 to 10
	Source 4 Gain	0	0 to 10
	IR Passthrough Status	Enabled	Press - to disable Press + to enable
	IR Status	Enabled	Press - to disable Press + to enable

If there is no interaction with the VSC for more than 20 seconds, the menu will be exited and the display will revert back to the source setting. You can also manually exit from the Advanced Menu by pressing and holding the **src** button for 2 seconds.

- Press and release the **src** button to advance to the next menu item.
- Press the **Power** button to go back to the previous menu item.
- Press the + button to adjust the current item.
- Press the - button to adjust the current item.

## Setting the Audio Zone

The Select Zone setting is used to logically connect the VSC to an audio zone on the Hi-Fi™ 2 4x4 system. To select the audio zone that the respective VSC will control, press the **+** button to increase the zone number or press the **-** button to decrease the zone number, and then press **src** button to select the zone and advance to the Source Connection Status settings. The Select Zone setting can range from 1 to 4.

You may have more than one VSC configured to a given audio zone. This is useful if you have a large room and would like multiple VSC keypads in that room to control the audio zone. When multiple VSC keypads are configured to an audio zone, all VSC keypads will mimic one another.

## Source Connection Status Settings

The Source Connection Status settings allow you to add and remove sources from the source cycle when scrolling through available sources. When the connection status for a source is set to disabled, it will not show up in the list of sources when cycling through the sources using a VSC or remote control. This is useful if you have unused sources. If you disable the unused sources, they will not show up in the cycle.

To enable the selected source, press the **+** button. To disable the selected source, press the **-** button. By default, all sources are connected (i.e. enabled). These settings are system-wide and affect all zones.

After modifying the connection status for all four sources, press and release the **src** button to advance to the Source Gain settings.

## Source Gain Settings

The Source Gain setting allows you to increase the volume of each audio source so that all sources are at the same relative volume.

To change the source gain setting, press the **+** button to increase the volume of the respective source and press the **-** button to decrease the volume of the respective source. These settings are system-wide and affect all zones.

After modifying the source gain for all four sources, press and release the **src** button to advance to the IR Passthrough setting.

## IR Passthrough

The IR Passthrough setting allows you to select whether IR signals from a remote control are routed to the connected audio source. When enabled, this allows you to remotely control a connected audio source from the respective VSC.

To change the IR Passthrough setting, press the **+** button to enable IR passthrough and press the **-** button to disable IR passthrough. This setting must be performed at the VSC in each audio zone and is applicable to that particular zone.

After modifying the IR Passthrough setting, press and release the **src** button to advance to the IR setting.

## IR

The IR setting allows you to set whether the IR signals received at the VSC are sent to the Hi-Fi™ 2 4x4 for processing. When enabled, the VSC will route IR signals to the *Hi-Fi 2 4x4* processor whenever an IR signal is received at the respective VSC.

To change the IR setting, press the + button to enable IR and press the – button to disable IR. This setting must be performed at the VSC in each audio zone and is applicable to that particular zone.

After modifying the IR setting, press and release the **src** button to exit the menu. The display will revert back to the source setting.

## IR Features

When an IR signal is received by a VSC, it is sent directly to the *Hi-Fi 2 4x4* processor. Upon receiving the IR data, the *Hi-Fi 2 4x4* processor will decode it and process certain commands locally and route all IR data to connected source equipment. IR must be enabled for the VSC to send IR data to the amplifier.

### Locally Processed IR

The items that are locally processed at the amplifier are mute toggle, volume increment, volume decrement, source change, power toggle, power on, and power off. When you press any of these remote buttons, the IR data is sent to the *Hi-Fi 2 4x4* processor. The *Hi-Fi 2 4x4* processor will respond by changing the required zone settings. Then the IR signal is routed to the audio source that the audio zone is connected to. For example, when you press the mute toggle button on the IR remote pointed at Zone 1 (connected to Source 3), the *Hi-Fi 2 4x4* processor will respond by muting Zone 1 and routing the IR data to Source 3.

If the volume increment or decrement IR command is received when the VSC is displaying the source, the display on the VSC is updated with the new volume. If the audio zone is currently muted and the VSC is displaying the source, then the first volume increment or decrement IR command will turn mute off and will result in the volume increasing or decreasing. Similarly if a source IR command is received, the display on the VSC is updated to show the new source.

## Using the IR Remote Control

To use the Hi-Fi™ 2 Remote Control, point it at the VSC for the respective audio zone, and press desired button(s) as follows:

- 1) **Power:** This button turns the respective audio zone on and off.
- 2) **Mute:** This button turns mute on and off in the respective audio zone.
- 3) **Previous:** This button is used to play the previous track on supported sources.
- 4) **Next:** This button is used to play the next track on supported sources.
- 5) **Play/Pause:** This button is used to toggle between play and pause on supported sources.
- 6) **Source:** This button is used to cycle through the available audio sources.
- 7) **Volume Down:** This button decreases the volume in the respective audio zone.
- 8) **Volume Up:** This button increases the volume in the respective audio zone.

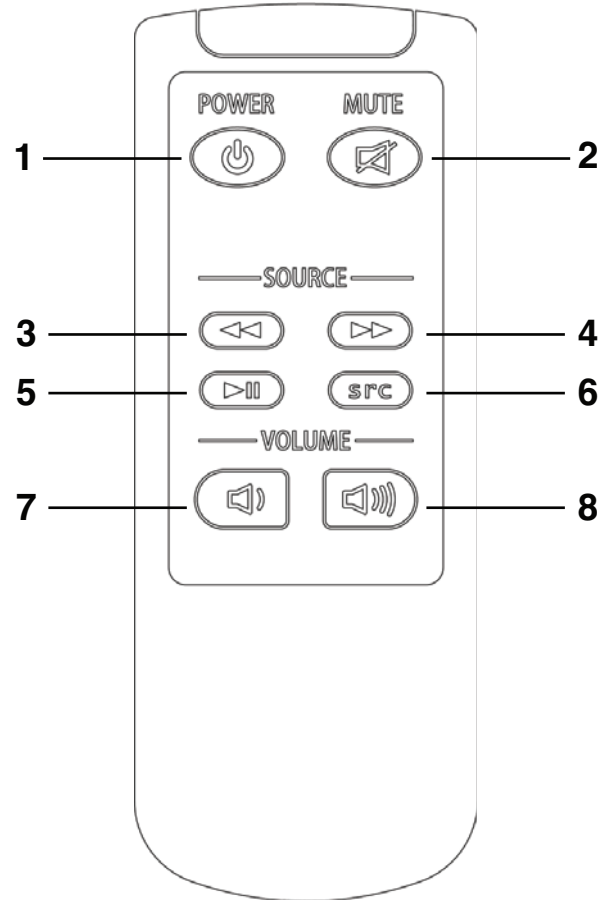

## IR Passthrough

When IR Passthrough is enabled, IR data can also be routed to the connected source equipment. After decoding the received IR, the *Hi-Fi 2* 4x4 processor will then route the IR signal to the source which is logically connected to that VSC.

## IR Output

Each RIM ships with an IR flasher (Part Number: 62A08-1). The IR flasher is used for sending IR data to the source equipment. When you point your source equipment remote control at the IR receiver in the VSC and send a signal, the IR data is routed to the appropriate RIM (to which the source is logically connected), which then sends the IR signal through the IR flasher to the source equipment.

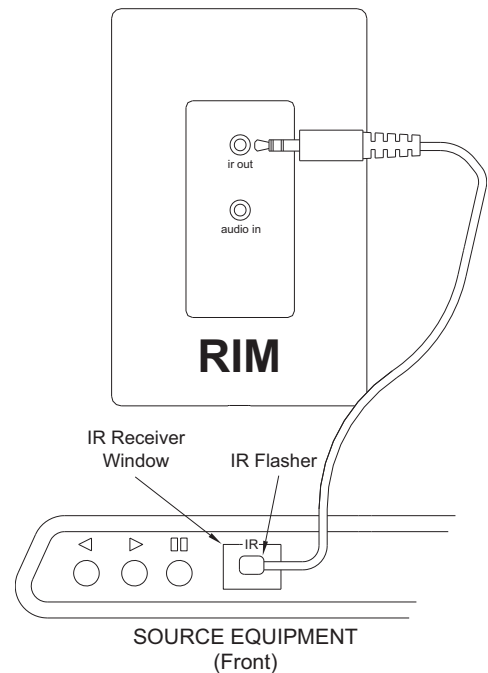

## Connecting Your Music Source

Each Remote Input Module (RIM) located throughout your house is used to pick up music from your LEVITON Dock (Part Number 96A00), home theater, kitchen TV, computer, personal music player, satellite radio, Media Center, CD player, or any music source with an audio output.

Plug any music source into a RIM using a standard stereo input jack. That music can then be shared with any room that has a Volume-Source Control (VSC).

For source equipment that has female RCA connectors, you may use the LEVITON 3.5mm male to 2 RCA male retractable patch cable (Part Number: 62A14-1).

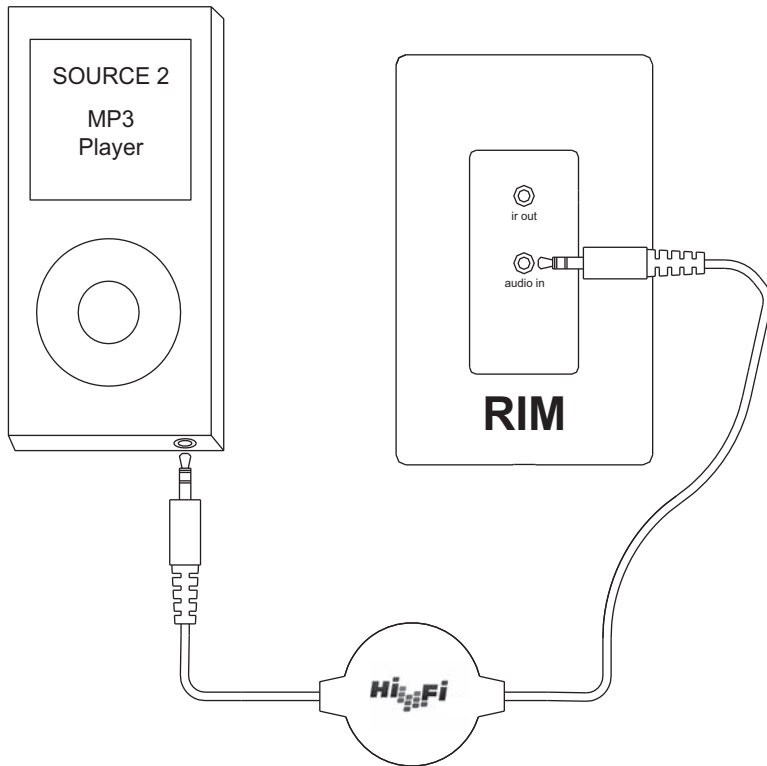
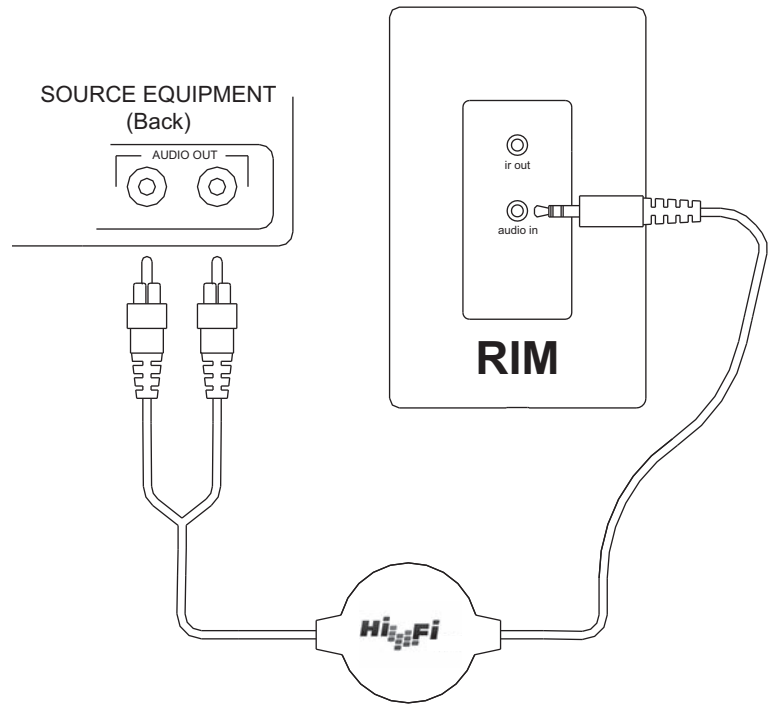

Bring your MP3 player to a room with a RIM, plug it in, and then enjoy your favorite music in any room with a VSC.

For source equipment that has a 3.5mm female connector (similar to an earphone jack), you may use the LEVITON 3.5mm male to 3.5mm male stereo retractable patch cable (Part Number: 62A13-1).



## Page / Mute

Hi-Fi™ 2 4x4 has the capability of playing audio over all speakers in your home in special circumstances. For example, it can announce when someone is at the door or when the telephone is ringing. This feature is called paging. If paging is used, the paging audio source will be connected as audio Source 4. When an audio page is initiated, all audio zones will be turned on at the paging volume that was configured in the Advanced Menu and switched to Source 4. When the page is complete, all audio zones will be returned to their previous source selection, power state, and volume setting.

When the *Hi-Fi 2 4x4* is making an announcement using the Page function, every VSC in the systems will display "Source 4", indicating that a page is being sent to all audio zones. Once the page is complete, every VSC will revert back to displaying its current source or turn off, as appropriate.

If desired, the Page function can be used to mute all audio zones instead of making an announcement. For example, you may simply want all of the audio zones on the *Hi-Fi 2 4x4* systems to be muted when someone is at the door or when the telephone is ringing. To configure *Hi-Fi 2 4x4* to mute all audio zones, set the Page Volume for each audio zone to "0" as described under "Page Volume Setting" in this guide.

## Zone Grouping

Your installer may have configured Zone Grouping in your system. Zone Grouping allows you to connect two or more audio zones to the same source, volume, and/or power state so that any or all of these items are controlled together. When audio zones are placed in a group, you can change any of the configured items from any VSC in that group.

An example of Zone Grouping may be a kitchen and family room that are openly connected. Both the kitchen and the family room have a VSC to be able to select and control audio. Zone grouping allows both of these audio zones to act as one larger audio zone.

Contact your installer for additional information about Zone Grouping.







#### FCC Compliance

This equipment has been tested and found to comply with the limits for a Class B digital device, pursuant to part 15 of the FCC Rules. These limits are designed to provide reasonable protection against harmful interference in a residential installation. This equipment generates, uses and can radiate radio frequency energy and, if not installed and used in accordance with the instructions, may cause harmful interference to radio communications. However, there is no guarantee that interference will not occur in a particular installation. If this equipment does cause harmful interference to radio or television reception, which can be determined by turning the equipment off and on, the user is encouraged to try to correct the interference by one or more of the following measures:

- Reorient or relocate the receiving antenna.
- Increase the separation between the equipment and receiver.
- Connect the equipment into an outlet on a circuit different from that to which the receiver is connected.
- Consult the dealer or an experienced radio/TV technician for help.

#### FOR CANADA ONLY

For warranty information and/or product returns, residents of Canada should contact Leviton in writing at **Leviton Manufacturing of Canada Ltd to the attention of the Quality Assurance Department, 165 Hymus Blvd, Pointe-Claire (Quebec), Canada H9R 1E9** or by telephone at **1 800 405-5320**.

#### LEVITON LIMITED WARRANTY

Leviton warrants to the original consumer purchaser and not for the benefit of anyone else that products manufactured by Leviton under the Leviton brand name ("Product") will be free from defects in material and workmanship for the time periods indicated below, whichever is shorter: • **OmniPro II and Lumina Pro**: three (3) years from installation or 42 months from manufacture date. • **OmniLT, Omni IIe, and Lumina**: two (2) years from installation or 30 months from manufacture date. • **Thermostats, Accessories**: two (2) years from installation or 30 months from manufacture date. • **Batteries**: Rechargeable batteries in products are warranted for ninety (90) days from date of purchase. **Note**: Primary (non-rechargeable) batteries shipped in products are not warranted. **Products with Windows® Operating Systems**: During the warranty period, Leviton will restore corrupted operating systems to factory default at no charge, provided that the product has been used as originally intended. Installation of non-Leviton software or modification of the operating system voids this warranty. Leviton's obligation under this Limited Warranty is limited to the repair or replacement, at Leviton's option, of Product that fails due to defect in material or workmanship. Leviton reserves the right to replace product under this Limited Warranty with new or remanufactured product. **Leviton will not be responsible for labor costs of removal or reinstallation of Product.** The repaired or replaced product is then warranted under the terms of this Limited Warranty for the remainder of the Limited Warranty time period or ninety (90) days, whichever is longer. This Limited Warranty does not cover PC-based software products. **Leviton is not responsible for conditions or applications beyond Leviton's control. Leviton is not responsible for issues related to improper installation, including failure to follow written installation and operation instructions, normal wear and tear, catastrophe, fault or negligence of the user or other problems external to the Product.** To view complete warranty and instructions for returning product, please visit us at [www.leviton.com](http://www.leviton.com).

#### Copyright and Trademark Information

This document and all its contents herein are subject to and protected by international copyright and other intellectual property rights and are the property of Leviton Manufacturing Co., Inc, its subsidiaries, affiliates and/or licensors.

Use herein of third party trademarks, service marks, trade names, brand names and/or product names are for informational purposes only, are/may be the trademarks of their respective owners; such use is not meant to imply affiliation, sponsorship, or endorsement.

No part of this document may be reproduced, transmitted or transcribed without the express written permission of Leviton Manufacturing Co., Inc.

For Technical Assistance Call: 800-824-3005  
[www.leviton.com](http://www.leviton.com)