



# Lumina™ RF Wireless Room Control System



# Designing a Lumina™ RF Wireless Room Control System

## How to Put It All Together

**1** Determine Which **LOADS** You Want to Control—lights, lamps, etc.

**2** Select the Appropriate **ROOM CONTROLLER\*** (One required per room)



Lumina RF Standalone App  
Apple/Google Store



Two-Way Communication with Lumina RF Standalone App



Keypad Room Controller (DLDNK)



Decora® Wall Switch Room Controller with 5A Relay\*\* (DL05S)



Decora® 0-10V Dimmer Room Controller with 5A Relay\*\* (DL057)



Two-Way Mesh Communication with Multiple Load Control and Peripheral Devices

\* Additional Room Controllers can be added to a system for multi-way switching.

\*\* Provides load control capabilities.

**3** Select Optional **LOAD CONTROL DEVICE(S)** As Needed—determine the required power and type of dimming (0-10V or phase cut)



20A ON/OFF Switching Power Pack (LU20S)



10A 0-10V Dimming Power Pack (LU107)



800W Phase Cut Dimming Power Pack (LU04P)



10A ON/OFF Decora® Wall Switch (ZS10S)



10A 0-10V Decora® Wall Dimmer (ZS057)



Zigbee Controlled Receptacle (ZSTLR)



Two-Way Mesh Communication with Room Controller

**4** Select Optional **SENSORS** As Needed



Wireless PIR Occupancy Sensor & Photocell (ZC015)



Two-Way Mesh Communication with Room Controller



# Lumina™ RF Wireless Components



The makeup of a Lumina RF Wireless Room Control System is simple: start with a Room Controller for simple switching, dimming and scene control. Then, add additional components for multi-location control, occupancy/vacancy sensing, daylight harvesting and more. The system is configured using the Lumina RF Standalone App—the only setup tool needed.

## Room Controllers

- The “brain” of the Lumina RF Standalone Room Control system
- Manages all the energy management functions in the space



Two-Way Communication with Lumina RF Standalone App



Two-Way Communication with Multiple Load Control and Peripheral Devices

Lumina RF Standalone App	Keypad Room Controller	Decora® Wall Switch Room Controller with 5A Relay	Decora® 0-10V Dimmer Room Controller with 5A Relay
Visit <a href="http://www.leviton.com/apps">www.leviton.com/apps</a> to download	<b>DLDNK</b>	<b>DL05S</b>	<b>DL057</b>
<ul style="list-style-type: none"> <li>• The only setup tool needed</li> </ul>	<ul style="list-style-type: none"> <li>• The “brain” of the system—just one room controller per space needed</li> <li>• Coordinates all the energy management functions in a space and provides multi-zone control, full range dimming, scene control and manual control</li> <li>• Additional wall switches and 0-10V dimmers available. 1-, 2-, 4-, 8-button keypads with custom engraving available</li> </ul>	<ul style="list-style-type: none"> <li>• The “brain” of the system—just one room controller per space needed</li> <li>• Provides ON/OFF control with additional room control capabilities available in the Keypad Room Controller</li> <li>• 0-10V dimming model available</li> </ul>	<ul style="list-style-type: none"> <li>• The “brain” of the system—just one room controller per space needed</li> <li>• Provides ON/OFF and dimming control with additional room control capabilities available in the Keypad Room Controller</li> <li>• Low voltage, 0-10V dimming model available</li> </ul>

## Wireless Load Control Devices

- Add to virtually any lamp or fixture for a wireless ON/OFF, 0-10V dimming and phase cut dimming solution
- Devices are paired directly to a room controller for an advanced wireless lighting and room control system



Two-Way Communication with Room Controller

20A ON/OFF Switching Power Pack	10A (0-10V) Dimming Power Pack	800W Phase Cut Dimming Power Pack
<b>LU20S</b>	<b>LU107</b>	<b>LU04P</b>
<ul style="list-style-type: none"> <li>• ON/OFF relay used for plug load control, motor loads, or non-dimming luminaires</li> </ul>	<ul style="list-style-type: none"> <li>• Used to dim any 0-10V controlled load</li> </ul>	<ul style="list-style-type: none"> <li>• Allows for dimming of full phase loads</li> </ul>

## Wireless Load Control Devices

- Manual switching and dimming for a variety of loads
- Devices are paired directly to a room controller for an advanced wireless lighting and room control system



Two-Way  
Communication  
with Room  
Controller

### Decora Wireless ON/OFF 10A Wall Switch

### Decora Wireless Low Voltage 24VDC Wall Dimmer

### Decora Wireless 10A 0-10V Wall Dimmers

### Zigbee Controlled Receptacle

ZS10S

ZS057-ALZ

ZS057-D0Z |  
ZS057-30Z

ZSTLR

- Used to control loads up to 10A
- Pair with the Lumina RF Room Controller for an advanced intelligent lighting system

- Robust, low voltage rocker manual switch with a dimming bar
- Provides control of any 0-10V dimming ballast or LED driver
- 24VDC is supplied by an OPP20 power pack which also switches the load ON and OFF

- Robust rocker manual switches with dimming bar used to provide wireless control of lighting loads including high inrush LED
- Used to control any 0-10V controlled load, or it can be paired with a Lumina RF Keypad Room Controller for an advanced intelligent lighting system

- Provides wireless ON/OFF plug load control of lamps, appliances and other similar devices up to 15A
- Can be installed in place of traditional wall receptacles with no additional wiring required

## Wireless Sensor

- Incorporate daylighting, occupancy/vacancy sensing, etc.



Two-Way  
Communication  
with Room  
Controller

### Wireless PIR Occupancy Sensor & Photocell

ZC015

- Designed to overcome placement and coverage challenges of traditional sensors
- Code compliant energy management functionality

# Applications



## Lumina RF 0-10V Dimming with Optional Occupancy/Vacancy Sensing, Multi-Zone Daylight Harvesting and Receptacle Control, Typical

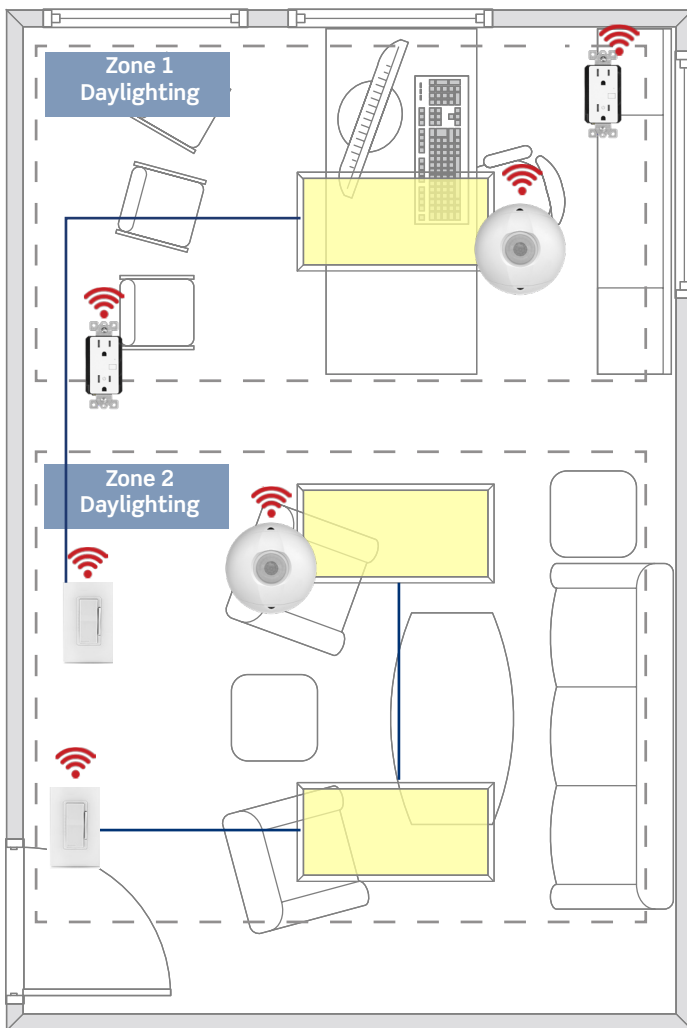

### Application Notes

- Room contains two zones of lighting, all configured through the Lumina RF App.
- Room has outward-facing windows.
- Individual zones respond to ambient light within the space.
- Occupant can access scenes and dimming/switching controls via their smart device, or by utilizing the manual Keypad control.
- **NOTE:** These are examples of applications but should not be considered limitations to product and solution capability. Please contact your local Leviton representative for design assistance.

### Sequence of Operation

- All Zones 1 and 2 lighting auto-ON to 50% and controlled receptacles on when occupancy is detected.
- Local control including dimming control of general lighting from keypads.
- Daylighting Zone 1 to dim based on photocell input when there is 150W or greater of lighting in the zone and sufficient daylight is available.
- All lighting and controlled receptacles to turn off automatically when the space is unoccupied after 20 minutes.

## Alternative Solutions

### Single Zone



#### Smart Wallbox Sensors

- Combines occupancy/vacancy sensing with 0-10V dimming or switching
- Integrated photocell for daylighting hold-OFF
- Configure additional capabilities with the Smart Sensor App

### Daylighting Zones 1 & 2



#### Provolt Room Controller (PRC)

- Integrates occupancy sensing, 0-10V dimming, daylighting, partial-ON, partial-OFF and demand response
- Configure using the Provolt App

## Lumina RF 0-10V Dimming with Optional Occupancy/Vacancy Sensing, Multi-Zone Daylight Harvesting and Receptacle Control, Typical

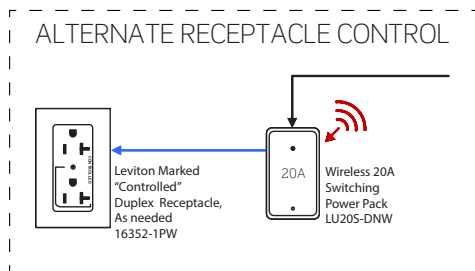

### Room Highlights

- 2 Zones
- Occupancy/Vacancy Sensing
- Daylighting
- Plug Load Control

### What You Will Need

### Quantity

	Decora 0-10V Dimmer Room Controller with 5A Relay DL057-D0Z	1
	Decora Wireless 0-10V Wall Dimmer ZS057-D0Z	1
	<b>ADD OPTIONAL OCCUPANCY/ VACANCY SENSING AND DAYLIGHT HARVESTING</b> Wireless PIR Occupancy Sensor & Photocell ZC015-BIW	2
	<b>ADD OPTIONAL RECEPTACLE CONTROL</b> Zigbee Controlled Receptacle ZSTLR-1HW*	2

\* LU20S-DNW can be used for an entire 20A receptacle control circuit as an alternative to ZSTLR-1HW and 16352-1PW at every receptacle.

### Code Requirements\*

<b>2021 IECC</b>	
• Section C405.2.1	• Occupancy Sensors
• <b>Section C405.2.6</b>	• <b>Interior Manual Lighting Controls</b>
• Section C405.2.3	• Daylight Responsive Controls
• <b>Section C405.2.4</b>	• <b>Daylight Zone Control</b>
• <b>C405.11.1</b>	• <b>Automatic Receptacle Control</b>
<b>ASHRAE 90.1 2022</b>	
• Section 8.4.2	• Receptacle/Plug Load Control
• Section 9.4.1	• Lighting Control
• Section 9.4.1.1	• Interior Lighting Control
<b>2022 Title 24, Part 6</b>	
• Section 130.1(a)	• Manual Area Controls
• Section 130.1(b)	• Multi-Level Controls • Dimming
• Section 130.1(c)	• Shut-Off Requirements • Occupancy Control • Partial-ON / Partial-OFF
• Section 130.1(d)	• Daylighting
• Section 130.1(f)	• Control Interactions
• Section 130.5(d)	• Receptacle/Plug Load Control (optional in classrooms)

\* Note that code updates are highlighted.

## Lumina RF 0-10V Dimming and Scene Control with Optional Occupancy/Vacancy Sensing and Multi-Zone Daylight Harvesting, Typical

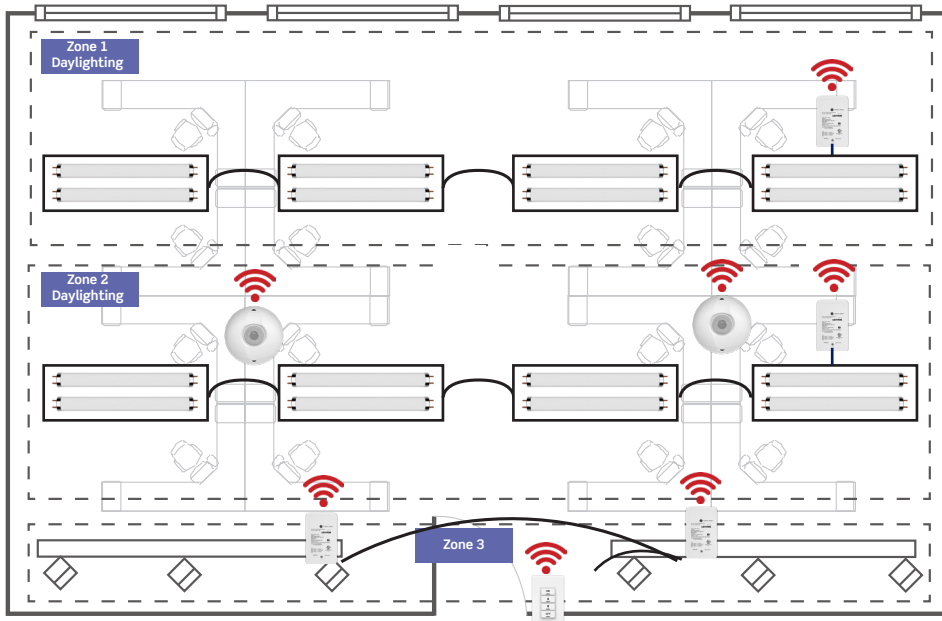

### Application Notes

- Room contains three separate zones of lighting, all configured through the Lumina RF App.
- Room has outward-facing windows.
- Individual daylighting zones respond to ambient light within the space.
- Lights in the zones can be dimmed or turned off as needed by space requirements.
- **NOTE:** These are examples of applications but should not be considered limitations to product and solution capability. Please contact your local Leviton representative for design assistance.

### Sequence of Operation

- All zone 1 and zone 2 lighting auto-on to 50% and controlled receptacles on when occupancy is detected.
- Local control including dimming control of general lighting from keypad.
- Daylighting zone 1 and daylighting zone 2 to dim based on photocell input when of lighting in the zone and sufficient daylight is available.
- All lighting to dim to 50% and controlled receptacles to turn off automatically when the space is unoccupied after 20 minutes.
- All lighting to turn off automatically when the space remains unoccupied for an additional 20 minutes



## Lumina RF 0-10V Dimming and Scene Control with Optional Occupancy/Vacancy Sensing and Multi-Zone Daylight Harvesting, Typical



### Room Highlights

- 3 Zones
- Occupancy/Vacancy Sensing
- Daylighting
- Load Control Dimming

### What You Will Need

### Quantity

	Lumina RF Keypad Room Controller DLDNK-04W	1
	Wireless 0-10V Dimming Power Pack LU107-DNW	2
	Wireless 800W Phase Cut Dimming Power Pack LU04P-IDW	2
	<b>ADD OPTIONAL OCCUPANCY/ VACANCY SENSING AND DAYLIGHT HARVESTING</b> Wireless PIR Occupancy Sensor & Photocell ZC015-BIW	2

### Code Requirements\*

<b>2021 IECC</b>	
• Section C405.2.1	• Occupancy Sensors
• Section C405.2.1.3	• Open Plan Office
• <b>Section C405.2.6</b>	• <b>Interior Manual Lighting Controls</b>
• Section C405.2.3	• Daylight Responsive Controls
• <b>Section C405.2.4</b>	• <b>Daylight Zone Control</b>
• <b>C405.11.1</b>	• <b>Automatic Receptacle Control</b>
<b>ASHRAE 90.1 2022</b>	
• Section 8.4.2	• Receptacle/Plug Load Control
• Section 9.4.1	• Lighting Control
• Section 9.4.1.1	• Interior Lighting Control
<b>2022 Title 24, Part 6</b>	
• Section 130.1(a)	• Manual Area Controls
• Section 130.1(b)	• Multi-Level Controls • Dimming
• Section 130.1(c)	• Shut-Off Requirements • Occupancy Control • Partial-ON / Partial-OFF
• Section 130.1(d)	• Daylighting
• Section 130.1(f)	• Control Interactions

\* Note that code updates are highlighted.

# Applications



## Lumina RF 0-10V Dimming with Optional Occupancy/Vacancy Sensing, Multi-Zone Daylight Harvesting and Receptacle Control

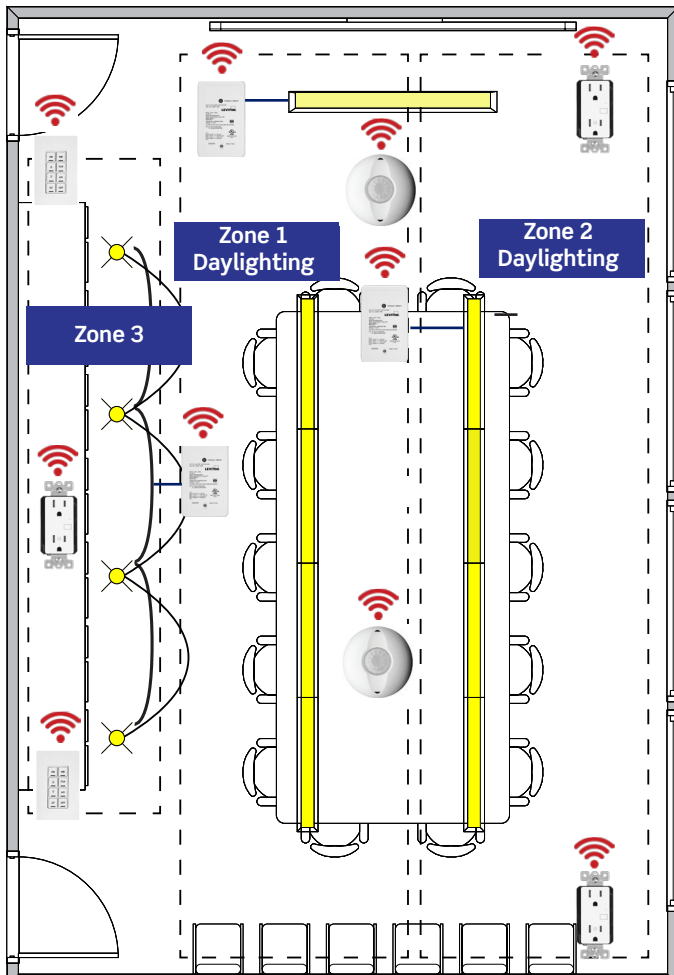

### Application Notes

- Room contains three separate zones of lighting, including a presentation screen which can be adjusted and configured through the Lumina RF App.
- Room has multiple entrances.
- Room has outward facing windows.
- **NOTE:** These are examples of applications but should not be considered limitations to product and solution capability. Please contact your local Leviton representative for design assistance.

### Sequence of Operation

- Zone 3 lighting manual-ON with keypads, and controlled receptacles auto-on when occupancy is detected.
- Local control, dimming control, and any required scene control of general lighting from keypads.
- Daylighting zones 1 and 2 to dim based on photocell input when there is 150W or greater of lighting in the zone and sufficient daylight is available
- All lighting and controlled receptacles to turn off automatically when the space is unoccupied after 20 minutes.

### Alternative Solutions

#### Single Zone



#### Smart Wallbox Sensors

- Combines occupancy/vacancy sensing with 0-10V dimming or switching
- Integrated photocell for daylighting hold-OFF
- Configure additional capabilities with the Smart Sensor App

#### Daylighting Zones 1 & 2



#### Provolt Room Controller (PRC)

- Integrates occupancy sensing, 0-10V dimming, daylighting, partial-ON, partial-OFF and demand response
- Configure using the Provolt App

# Lumina RF 0-10V Dimming with Optional Occupancy/Vacancy Sensing, Multi-Zone Daylight Harvesting and Receptacle Control

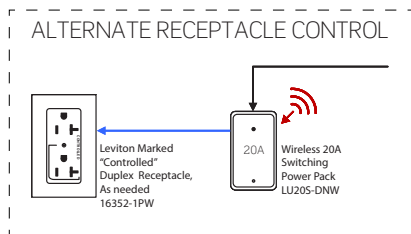

## Room Highlights

- 3 Zones
- Occupancy/Vacancy Sensing
- Scene Control
- Daylighting
- Multi-Way Switching
- Plug Load Control

## What You Will Need

### Quantity

	Lumina RF Keypad Room Controller DLDNK-08W	2
	Wireless 0-10V Dimming Power Pack LU107-DNW	3
	<b>ADD OPTIONAL OCCUPANCY/ VACANCY SENSING AND DAYLIGHT HARVESTING</b> Wireless PIR Occupancy Sensor & Photocell ZSC04-INW	2
	<b>ADD OPTIONAL RECEPTACLE CONTROL</b> Zigbee Controlled Receptacle ZSTLR-1HW*	3

\* LU20S-DNW can be used for an entire 20A receptacle control circuit as an alternative to ZSTLR-1HW and 16352-1PW at every receptacle.

## Code Requirements\*

<b>2021 IECC</b>	
• Section C405.2.1	• Occupancy Sensors
• Section C405.2.6	• Interior Manual Lighting Controls
• Section C405.2.3	• Daylight Responsive Controls
• Section C405.2.4	• Daylight Zone Control
• C405.11.1	• Automatic Receptacle Control
<b>ASHRAE 90.1 2022</b>	
• Section 8.4.2	• Receptacle/Plug Load Control
• Section 9.4.1	• Lighting Control
• Section 9.4.1.1	• Interior Lighting Control
<b>2022 Title 24, Part 6</b>	
• Section 130.1(a)	• Manual Area Controls
• Section 130.1(b)	• Multi-Level Controls • Dimming
• Section 130.1(c)	• Shut-Off Requirements • Occupancy Control • Partial-ON / Partial-OFF
• Section 130.1(d)	• Daylighting
• Section 130.1(f)	• Control Interactions
• Section 130.5(d)	• Receptacle/Plug Load Control (optional in classrooms)

\* Note that code updates are highlighted.

## Lumina RF 0-10V Dimming and Occupancy/Vacancy Sensing with Optional Multi-Zone Daylight Harvesting and Receptacle Control

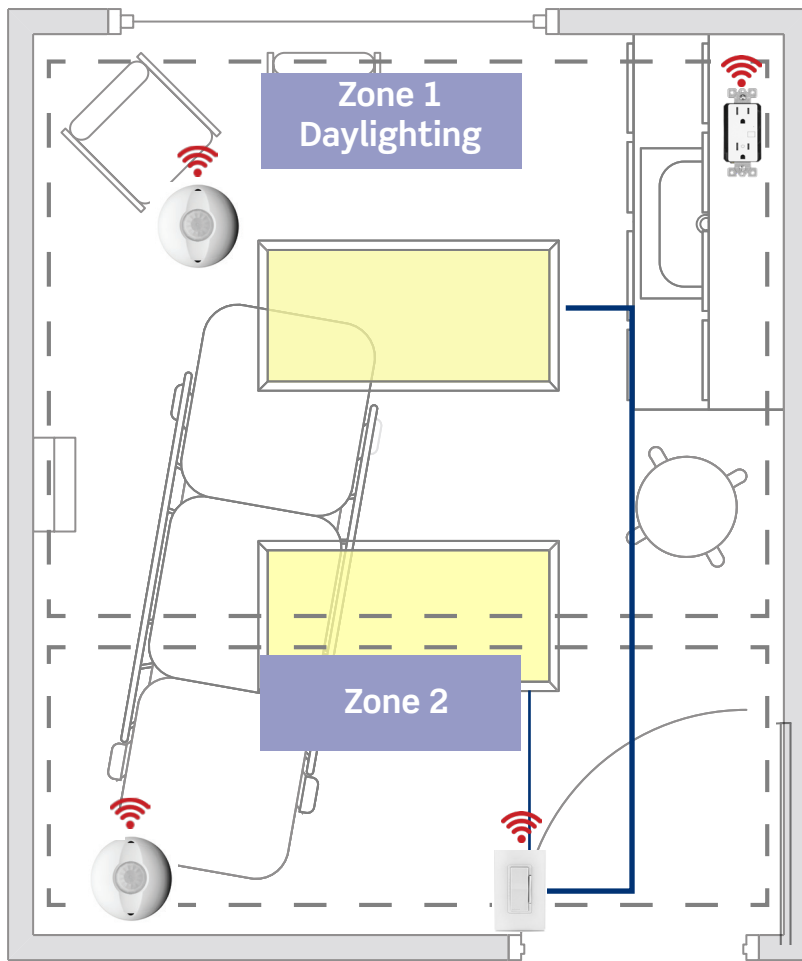

### Application Notes

- Room contains two separate zones of lighting, all configured through the Lumina RF App.
- Room has ambient and natural light.
- Lights are ON when the room is occupied and OFF when the space is empty.
- Light levels adjust to natural light in the space
- **NOTE:** These are examples of applications but should not be considered limitations to product and solution capability. Please contact your local Leviton representative for design assistance.

### Sequence of Operation

- Zone 1 lighting manual-ON with keypad, and controlled receptacles auto-ON when occupancy is detected.
- Local control including dimming control of general lighting from keypad.
- Daylighting zone 1 to dim based on photocell input when there is 150W or greater of lighting in the zone and sufficient daylight is available.
- All lighting and controlled receptacles to turn off automatically when the space is unoccupied after 20 minutes.

## Alternative Solutions

### Single Zone



#### Smart Wallbox Sensors

- Combines occupancy/vacancy sensing with 0-10V dimming or switching
- Integrated photocell for daylighting hold-OFF
- Configure additional capabilities with the Smart Sensor App

### Daylighting Zone 1



#### Provolt Room Controller (PRC)

- Integrates occupancy sensing, 0-10V dimming, daylighting, partial-ON, partial-OFF and demand response
- Configure using the Provolt App

## Lumina RF 0-10V Dimming and Occupancy/Vacancy Sensing with Optional Multi-Zone Daylight Harvesting and Receptacle Control

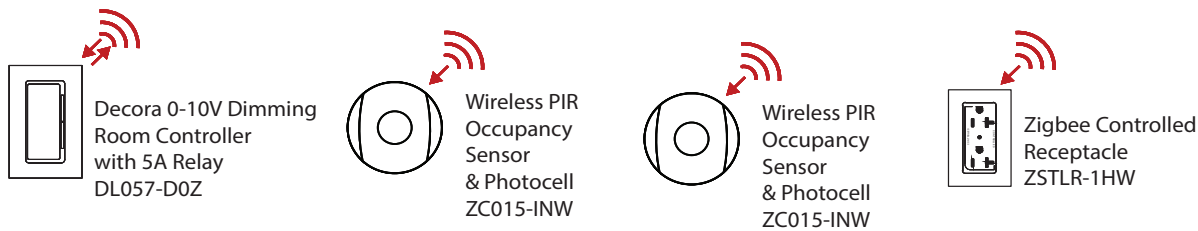

### Room Highlights

- 2 Zones
- Occupancy/Vacancy Sensing
- Daylighting
- Plug Load Control

### What You Will Need

### Quantity

	Decora Wall Switch Room Controller with 5A Relay DL057-D0Z	1
	<b>ADD OPTIONAL OCCUPANCY/VACANCY SENSING AND DAYLIGHT HARVESTING</b> Wireless PIR Occupancy Sensor & Photocell ZC015-INW	2
	<b>ADD OPTIONAL RECEPTACLE CONTROL</b> Wireless Controlled Receptacle ZSTLR-1HW*	Varies

\* LU20S-DNW can be used for an entire 20A receptacle control circuit as an alternative to ZSTLR-1HW at every other receptacle.

### Code Requirements\*

2021 IECC	
• Section C405.2.1	• Occupancy Sensors
• <b>Section C405.2.6</b>	• <b>Interior Manual Lighting Controls</b>
• Section C405.2.3	• Daylight Responsive Controls
• <b>Section C405.2.4</b>	• <b>Daylight Zone Control</b>
• <b>C405.11.1</b>	• <b>Automatic Receptacle Control</b>
ASHRAE 90.1 2022	
• Section 8.4.2	• Receptacle/Plug Load Control
• Section 9.4.1	• Lighting Control
• Section 9.4.1.1	• Interior Lighting Control
2022 Title 24, Part 6	
• Section 130.1(a)	• Manual Area Controls
• Section 130.1(b)	• Multi-Level Controls • Dimming
• Section 130.1(c)	• Shut-Off Requirements • Occupancy Control • Partial-ON / Partial-OFF
• Section 130.1(d)	• Daylighting
• Section 130.1(f)	• Control Interactions
• Section 130.5(d)	• Receptacle/Plug Load Control (optional in classrooms)

\* Note that code updates are highlighted.

# Applications



## Lumina RF 0-10V Dimming, Phase Cut Dimming, and Scene Control with Optional Occupancy/Vacancy Sensing, Multi-Zone Daylight Harvesting and Receptacle Control

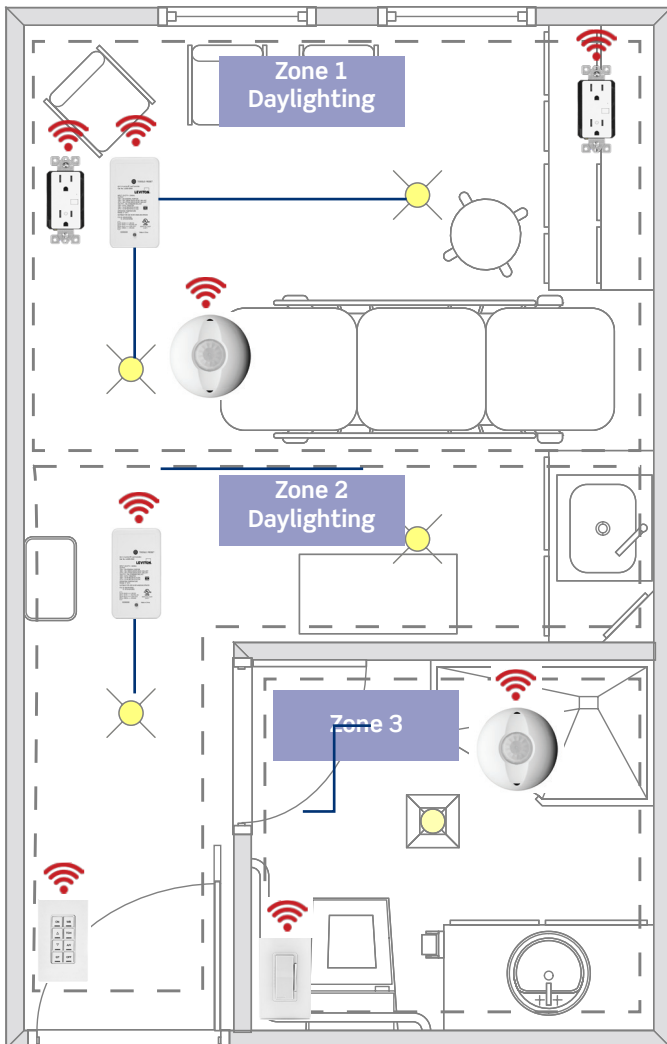

### Application Notes

- Room contains three separate zones of lighting.
- Room has a restroom requiring occupancy sensing and auto-OFF.
- Room has outward facing windows
- Individual zones respond to ambient light within the space.
- **NOTE:** These are examples of applications but should not be considered limitations to product and solution capability. Please contact your local Leviton representative for design assistance.

### Sequence of Operation (Room)

- Zones 1 and lighting manual-ON with keypad, and controlled receptacles auto-on when occupancy is detected.
- Local control including dimming control of general lighting from keypad.
- Daylighting zone 1 to dim based on photocell input when there is 150W or greater of lighting in the zone and sufficient daylight is available.
- All lighting and controlled receptacles to turn off automatically when the space is unoccupied after 20 minutes.

### Sequence of Operation (Restroom)

- Lighting auto-on to 50% when occupancy is detected.
- Local control including dimming control of general lighting from keypad.
- All lighting to turn off automatically when the space is unoccupied after 20 minutes.

## Alternative Solutions

### Single Zone



#### Smart Wallbox Sensors

- Combines occupancy/vacancy sensing with 0-10V dimming or switching
- Integrated photocell for daylighting hold-OFF
- Configure additional capabilities with the Smart Sensor App

### Daylighting Zones 1 & 2



#### Provolt Room Controller (PRC)

- Integrates occupancy sensing, 0-10V dimming, daylighting, partial-ON, partial-OFF and demand response
- Configure using the Provolt App

# Lumina RF 0-10V Dimming, Phase Cut Dimming, and Scene Control with Optional Occupancy/Vacancy Sensing, Multi-Zone Daylight Harvesting and Receptacle Control

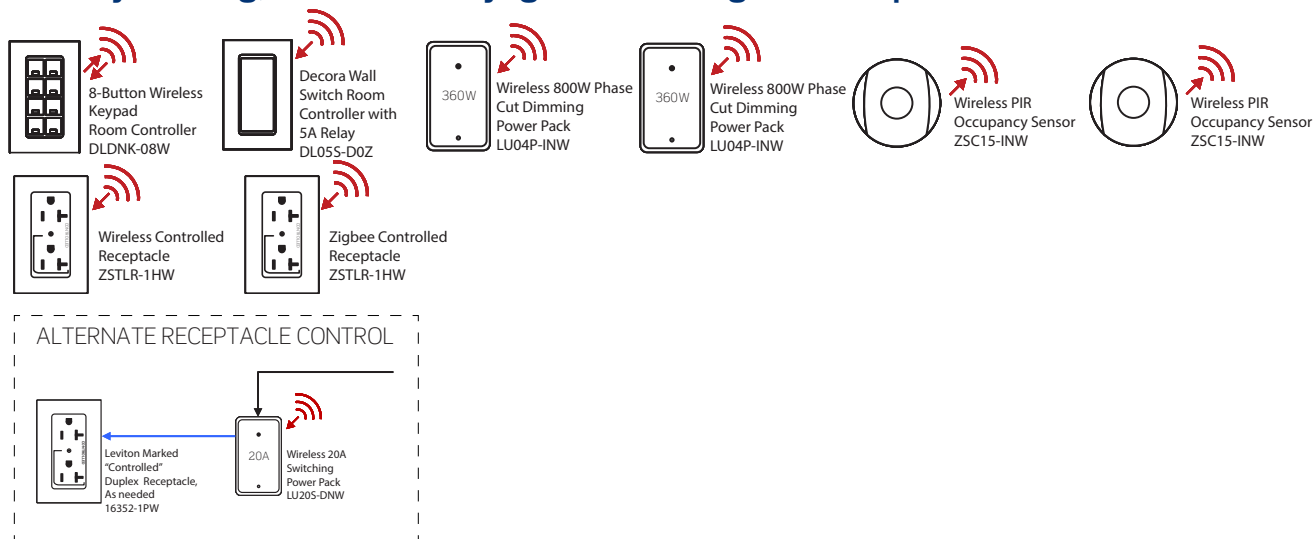

## Room Highlights

- 3 Zones
- Occupancy/Vacancy Sensing
- Daylighting
- Plug Load Control

## What You Will Need

## Quantity

	Lumina RF Keypad Room Controller DLDNK-08W	1
	Decora Wall Switch Room Controller with 5A Relay DL05S-D0Z	1
	Wireless 800W Phase Cut Dimming Power Pack LU04P-INW*	2
	<b>ADD OPTIONAL OCCUPANCY/ VACANCY SENSING AND DAYLIGHT HARVESTING</b> Wireless PIR Occupancy Sensor ZC015-BIW	2
	<b>ADD OPTIONAL RECEPTACLE CONTROL</b> Zigbee Controlled Receptacle ZSTLR-1HW*	2

\* LU20S-DNW can be used for an entire 20A receptacle control circuit as an alternative to ZSTLR-1HW and 16352-1PW at every receptacle.

## Code Requirements\*

<b>2021 IECC</b>	
• Section C405.2.1	• Occupancy Sensors
• Section C405.2.2.2	• Interior Manual Lighting Controls
	• Light Reduction Controls
• Section C405.2.3	• Daylight Responsive Controls
• Section C405.2.3.1	• Daylight Zone Control
• C405.2.4	• Specific Application Controls— Receptacle Controls
• Section C408.3	• Functional Testing
<b>ASHRAE 90.1 2022</b>	
• Section 8.4.2	• Receptacle/Plug Load Control
• Section 9.4.1	• Lighting Control
• Section 9.4.1.1	• Interior Lighting Control
<b>2022 Title 24, Part 6</b>	
• Section 130.1(a)	• Area Controls
	• Manual ON/OFF
• Section 130.1(b)	• Multi-Level Controls
	• Dimming
• Section 130.1(c)	• Shut-Off Requirements
	• Occupancy Control
	• Partial-ON / Partial-OFF
• Section 130.1(d)	• Daylighting
• Section 130.1(f)	• Control Interactions
• Section 130.5(d)	• Receptacle/Plug Load Control (optional in classrooms)

\* Note that code updates are highlighted.

## Lumina RF 0-10V Dimming, Phase Cut Dimming, Switching and Occupancy/Vacancy Sensing

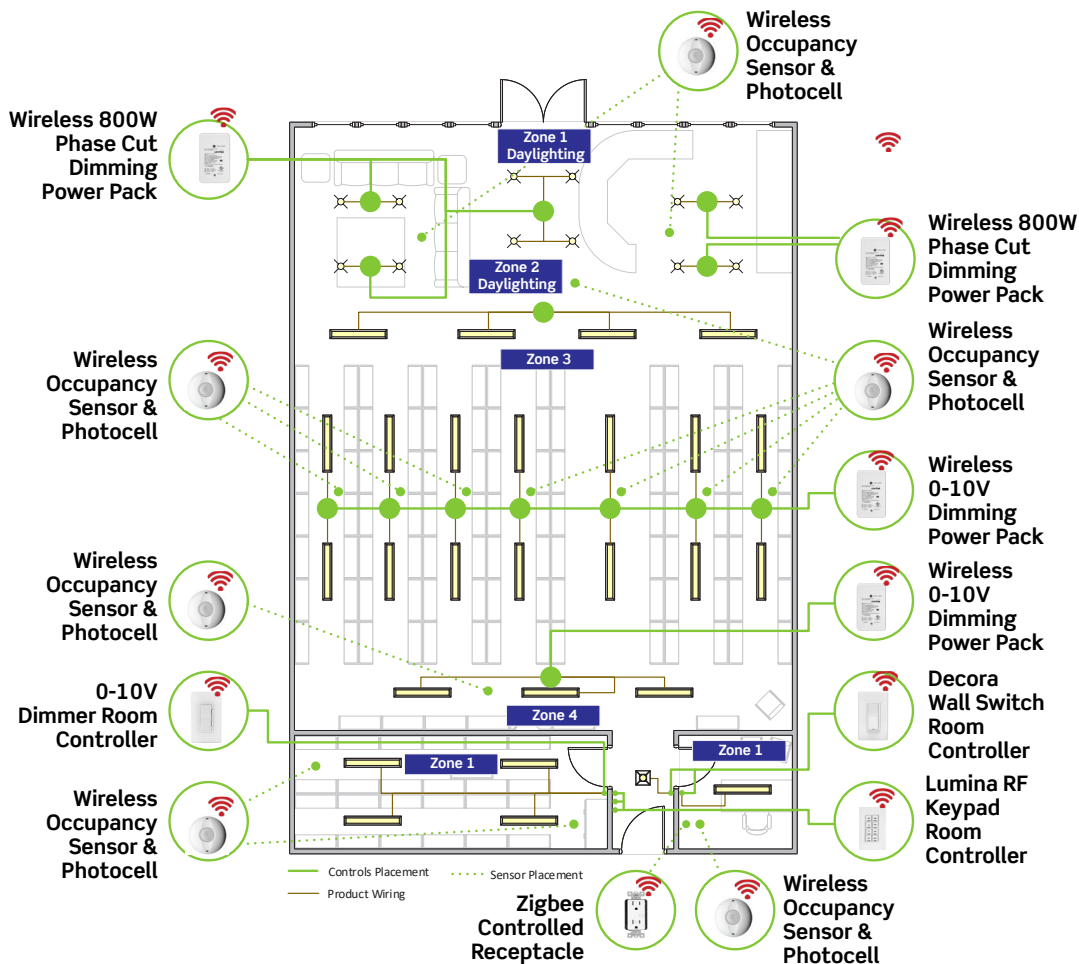

### Application Notes

- Space contains multiple zones, each requiring unique controls.
- Room contains aisles and bookshelves requiring occupancy sensing for each row.
- Individual spaces require occupancy sensing, dimming and manual controls.
- **NOTE:** These are examples of applications but should not be considered limitations to product and solution capability. Please contact your local Leviton representative for design assistance.

### Sequence of Operation (Library)

- Zones 1, 2, 3, and 4 lighting auto-ON to 100% and controlled receptacles auto-on when occupancy is detected.
- Local control, dimming control, and any required scene control of general lighting from keypads.
- Daylighting zone 1 and daylighting zone 2 to dim based on photocell input when there is 150W or greater of lighting in the zone and sufficient daylight is available.
- All lighting to dim to 50% and controlled receptacles to turn off automatically when the space is unoccupied after 20 minutes
- All lighting to turn off automatically when the space remains unoccupied for an additional 60 minutes.

### Sequence of Operation (Storage Room)

- Zone 1 lighting auto-on to 50% when occupancy is detected.
- Local control including dimming control of general lighting from keypad.
- All lighting to turn off automatically when the space is unoccupied after 20 minutes.

### Sequence of Operation (Office)

- Zone 1 lighting auto-on to 50% when occupancy is detected.
- Local control including dimming control of general lighting from keypad.
- All lighting to turn off automatically when the space is unoccupied after 20 minutes.



# Lumina RF 0-10V Dimming, Phase Cut Dimming, Switching and Occupancy/Vacancy Sensing

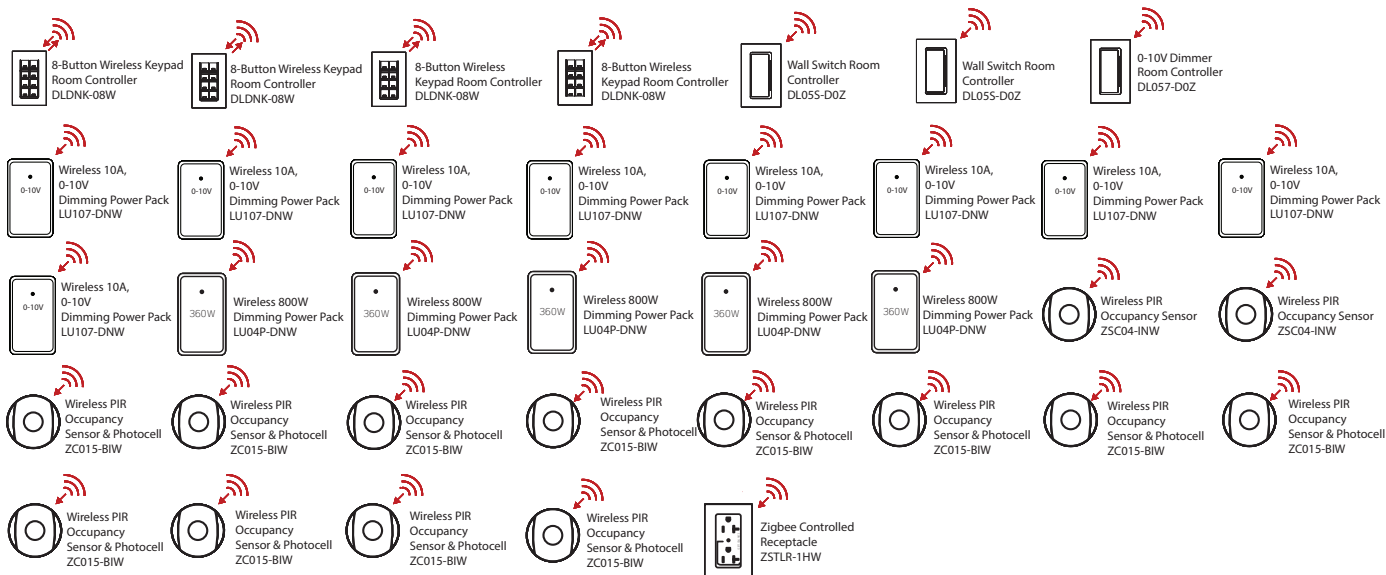

## Room Highlights

- 6 Zones
- Occupancy/Vacancy Sensing
- Daylighting
- Scene Control
- Plug Load Control

## What You Will Need

## Quantity

	Lumina RF Keypad Room Controller DLDNK-08W	4
	Decora Wall Switch Room Controller with 5A Relay DL055-D0Z	2
	Decora 0-10V Dimmer Room Controller with 5A Relay DL057-D0Z	1
	Wireless 10A 0-10V Dimming Power Pack LU107-DNW	9
	Wireless 800W Phase Cut Dimmer Power Pack LU04P-DNW	5
	Wireless Occupancy Sensor & Photocell ZC015-BIW	14
	Zigbee Controlled Receptacle ZSTLR-1HW	Varies

## Code Requirements\*

<b>2021 IECC</b>	
• Section C405.2.1	• Occupancy Sensors
• Section C405.2.2.2	• Interior Manual Lighting Controls
	• Light Reduction Controls
• Section C405.2.3	• Daylight Responsive Controls
• Section C405.2.3.1	• Daylight Zone Control
• C405.2.4	• Specific Application Controls—Receptacle Controls
• Section C408.3	• Functional Testing
<b>ASHRAE 90.1 2022</b>	
• Section 8.4.2	• Receptacle/Plug Load Control
• Section 9.4.1	• Lighting Control
• Section 9.4.1.1	• Interior Lighting Control
<b>2022 Title 24, Part 6</b>	
• Section 130.1(a)	• Area Controls
	• Manual ON/OFF
• Section 130.1(b)	• Multi-Level Controls
	• Dimming
• Section 130.1(c)	• Shut-Off Requirements
	• Occupancy Control
	• Partial-ON / Partial-OFF
• Section 130.1(d)	• Daylighting
• Section 130.1(f)	• Control Interactions
• Section 130.5(d)	• Receptacle/Plug Load Control (optional in classrooms)

\* Note that code updates are highlighted.

## Lumina RF 0-10V Dimming and Phase Cut Dimming and Occupancy Sensing with Optional Daylight Harvesting

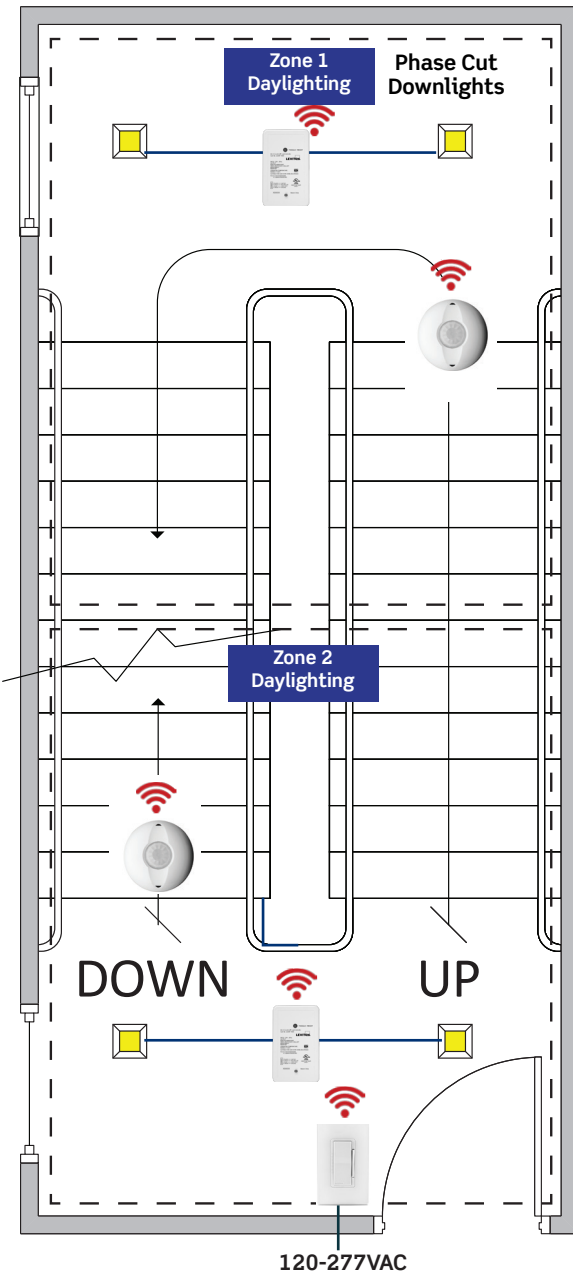

### Application Notes

- Space contains two separate zones of lighting.
- Space contains outward-facing windows.
- Space is not continuously occupied requiring occupancy sensors for energy savings.
- Individual zones respond to ambient light within the space.
- **NOTE:** These are examples of applications but should not be considered limitations to product and solution capability. Please contact your local Leviton representative for design assistance.

### Sequence of Operation

- Zones 1 and 2 lighting manual on with keypads, and controlled receptacles auto-on when occupancy is detected.
- Local control, dimming control, and any required scene control of general lighting from keypads.
- All lighting to dim to 50% and controlled receptacles to turn off automatically when the space is unoccupied after 20 minutes
- All lighting to turn off automatically when the space remains unoccupied for an additional 20 minutes.

## Lumina RF 0-10V Dimming and Phase Cut Dimming and Occupancy Sensing with Optional Daylight Harvesting

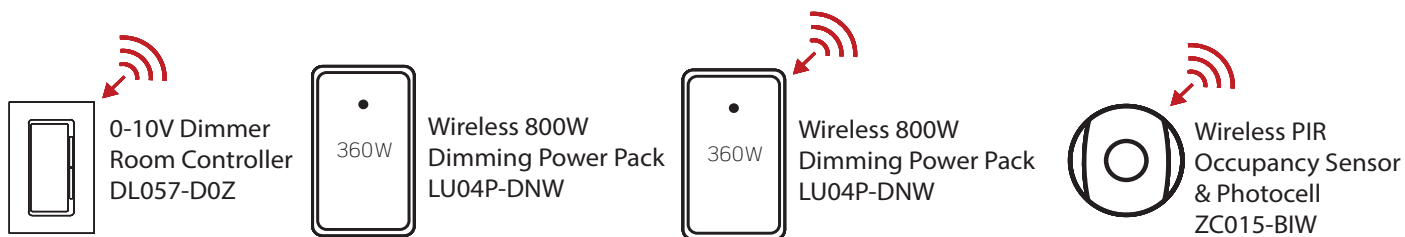

### Room Highlights

- 2 Zones
- Occupancy/Vacancy Sensing
- Phase Cut Dimming
- Daylighting

### What You Will Need

		Quantity
	Decora 0-10V Dimmer Room Controller with 5A Relay DL057-D0Z	1
	Wireless 800W Phase Cut Dimming Power Pack LU04P-1NW	2
	Wireless Occupancy Sensor & Photocell ZC015-BIW	2

### Code Requirements\*

<b>2021 IECC</b>	
• <b>Section C405.2.1</b>	• <b>Occupancy Sensors</b>
• Section C405.2.2.1	• Automatic Time Switch Control
• <b>Section C405.2.2.2</b>	• <b>Interior Manual Lighting Controls</b>
	• <b>Light Reduction Controls</b>
• Section C405.2.3	• Daylight Responsive Controls
• <b>Section C405.2.3.1</b>	• <b>Daylight Zone Control</b>
• Section C408.3	• Functional Testing
<b>ASHRAE 90.1 2022</b>	
• Section 9.4.1	• Lighting Control
• Section 9.4.1.1	• Interior Lighting Control
• Section 9.4.3	• Functional Testing
<b>2022 Title 24, Part 6</b>	
• Section 130.1(a)	• Area Controls
	• Manual ON/OFF
• Section 130.1(b)	• Multi-Level Controls
	• Dimming
• Section 130.1(c)	• Shut-Off Requirements
	• Occupancy Control
	• Partial-ON / Partial-OFF
• Section 130.1(d)	• Daylighting
• Section 130.1(f)	• <b>Control Interactions</b>

\* Note that code updates are highlighted.

## Lumina RF 3-Zone Plus Whiteboard, Daylighting, and Receptacle Control

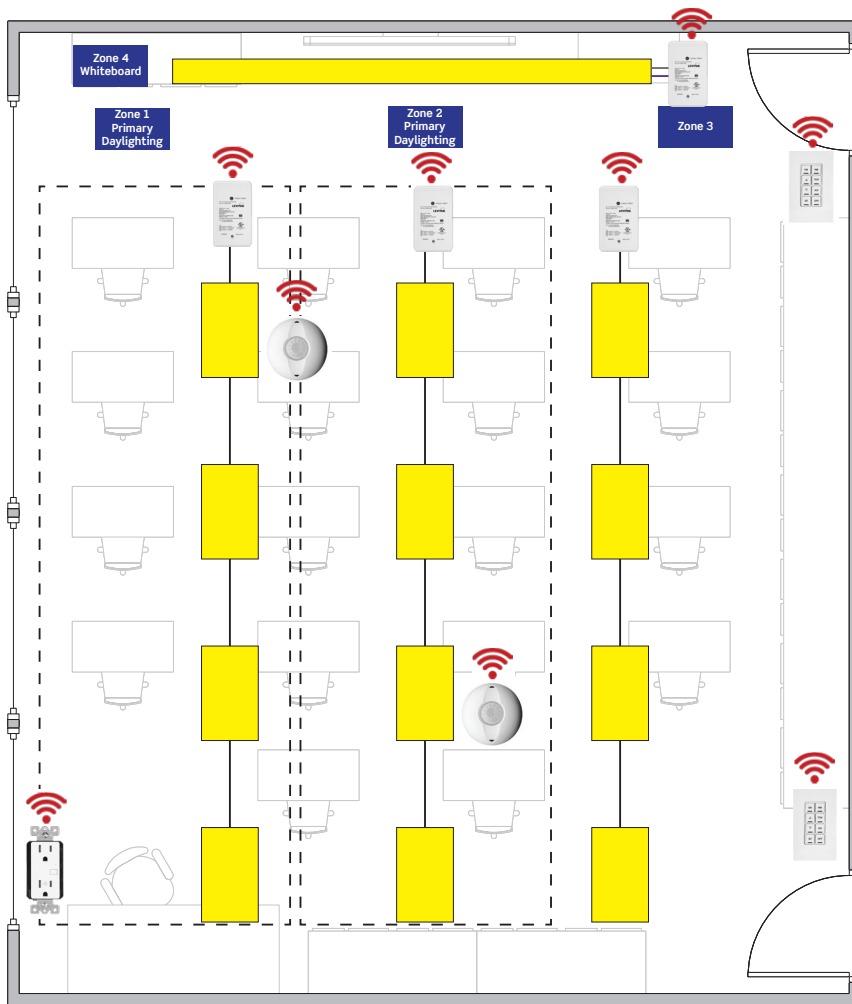

### Application Notes

- Space contains four separate zones of lighting configured, with one specifically for the whiteboard and teaching area; a second above the computer lab area; and two others above student desks.
- Zones can be rearranged, combined, or deleted with any changes to the usage or setup of the area.
- Instructors can adjust lighting and access scenes via the Lumina RF Standalone App or the Room Controller Keypad.
- **NOTE:** These are examples of applications but should not be considered limitations to product and solution capability. Please contact your local Leviton representative for design assistance.

### Sequence of Operation

- Zones 1, 2, 3, and 4 lighting manual on with keypads, and controlled receptacles auto-on when occupancy is detected.
- Local control, dimming control, and any required scene control of general lighting from keypads.
- All lighting to dim to 50% and controlled receptacles to turn off automatically when the space is unoccupied after 20 minutes.
- All lighting to turn off automatically when the space remains unoccupied for an additional 20 minutes.

### Alternative Solutions

#### Daylighting Zones 1 & 2



#### Provolt Room Controller (PRC)

- Integrates occupancy sensing, 0-10V dimming, daylighting, partial-ON, partial-OFF and demand response
- Configure using the Provolt App

## Lumina RF 3-Zone Plus Whiteboard, Daylighting, and Receptacle Control

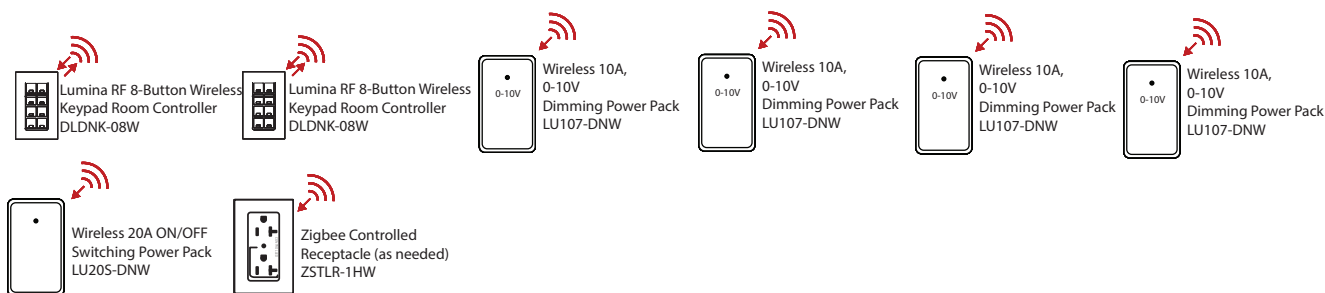

### Room Highlights

- 2 Zones
- Occupancy /Vacancy Sensing
- Daylighting
- Plug Load Control

### What You Will Need

		Quantity
	Lumina RF Wireless Keypad Room Controller DLDNK-08W	2
	Wireless 10A 0-10V Dimming Power Pack LU107-DNW	4
	Wireless 20A ON/OFF Switching Power Pack LU20S-DNW*	1
	Wireless Occupancy Sensor & Photocell ZC015-BIW	2
	<b>ADD OPTIONAL RECEPTACLE CONTROL</b> Zigbee Controlled Receptacle ZSTLR-1HW	Varies

\* ZSTLR can be used for an entire 20A receptacle control circuit as an alternative to LU20S-DNW and 16352-1PW at every receptacle.

### Code Requirements\*

2021 IECC	
• Section C405.2.1	• Occupancy Sensors
• Section C405.2.2.2	• Interior Manual Lighting Controls
	• Light Reduction Controls
• Section C405.2.3	• Daylight Responsive Controls
• Section C405.2.3.1	• Daylight Zone Control
• C405.2.4	• Specific Application Controls—Receptacle Controls
• Section C408.3	• Functional Testing
ASHRAE 90.1 2022	
• Section 8.4.2	• Receptacle/Plug Load Control
• Section 9.4.1	• Lighting Control
• Section 9.4.1.1	• Interior Lighting Control
2022 Title 24, Part 6	
• Section 130.1(a)	• Area Controls
	• Manual ON/OFF
• Section 130.1(b)	• Multi-Level Controls
	• Dimming
• Section 130.1(c)	• Shut-Off Requirements
	• Occupancy Control
	• Partial-ON / Partial-OFF
• Section 130.1(d)	• Daylighting
• Section 130.1(f)	• Control Interactions
• Section 130.5(d)	• Receptacle/Plug Load Control (optional in classrooms)

\* Note that code updates are highlighted.

# Wiring Diagrams

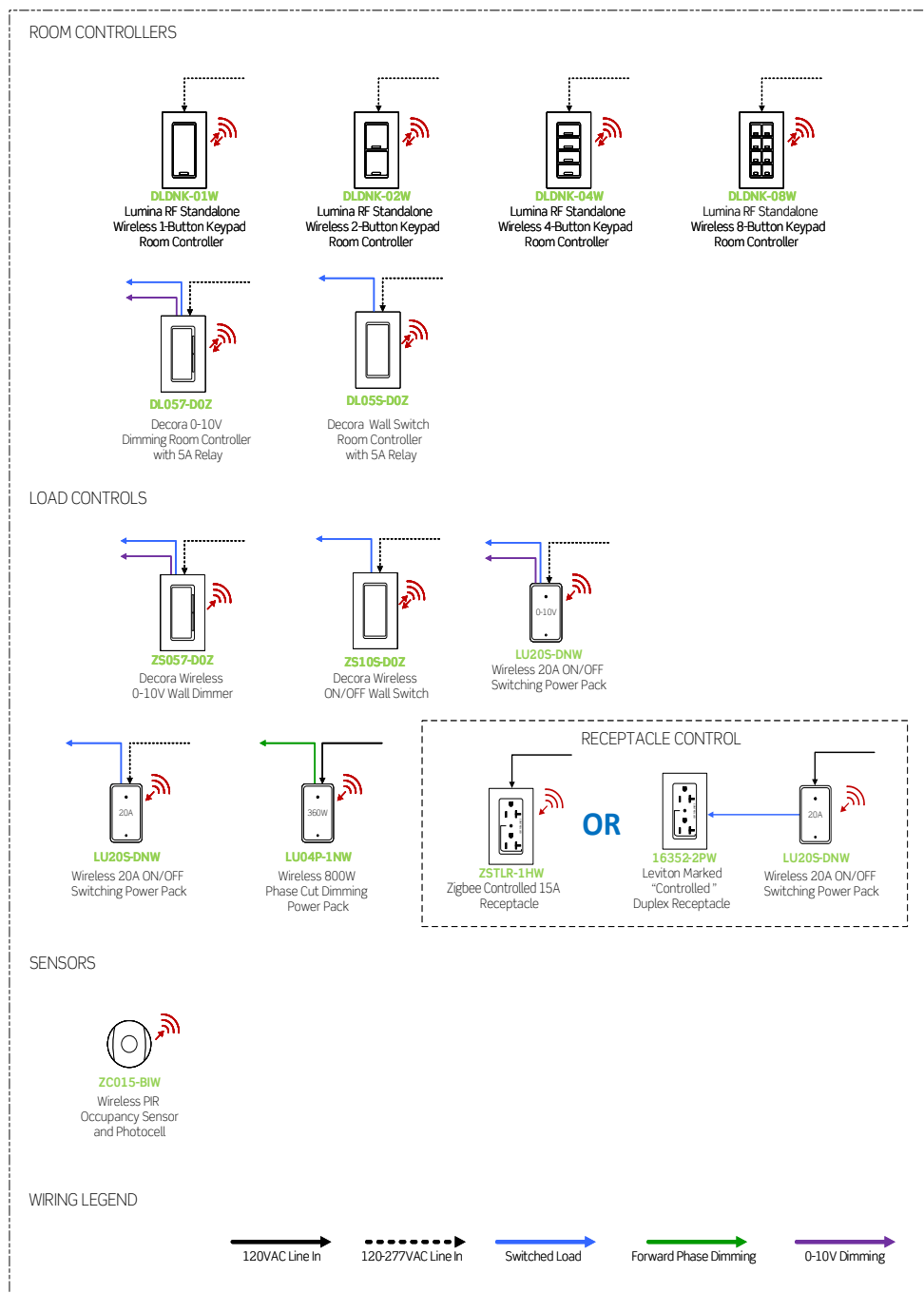

**TYPICAL OF AUTO ON/OFF 0-10V DIMMING RETROFIT WITH MULTI-LOCATION MANUAL CONTROL**

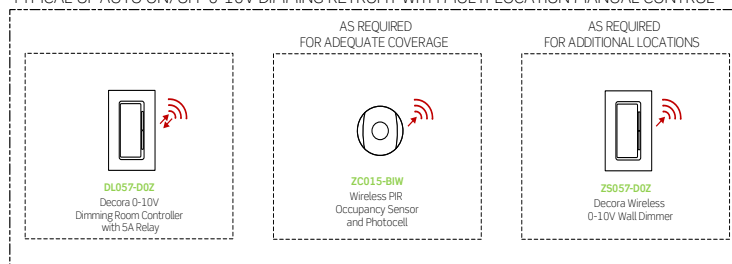

MIN OF (1) ROOM CONTROLLER REQUIRED PER ROOM  
MAX OF (60) NODES PER ROOM

TYPICAL OF AUTO ON/OFF FORWARD PHASE DIMMING RETROFIT WITH SCENE CONTROL

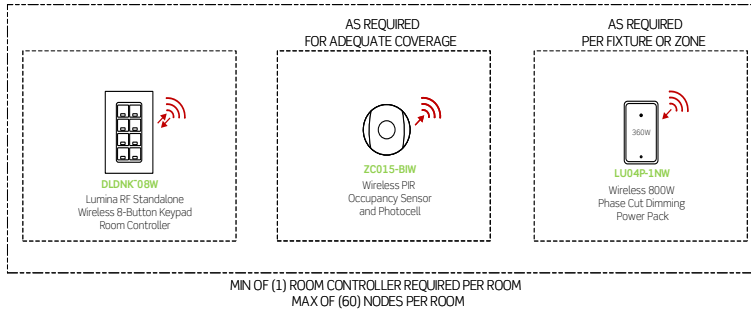

TYPICAL OF AUTO ON/OFF 0-10V DIMMING RETROFIT WITH DAYLIGHT HARVESTING

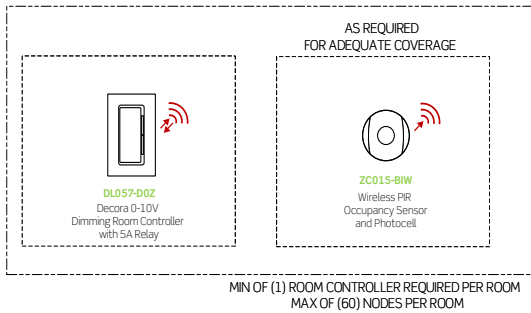

TYPICAL OF AUTO ON/OFF RETROFIT SOLUTION

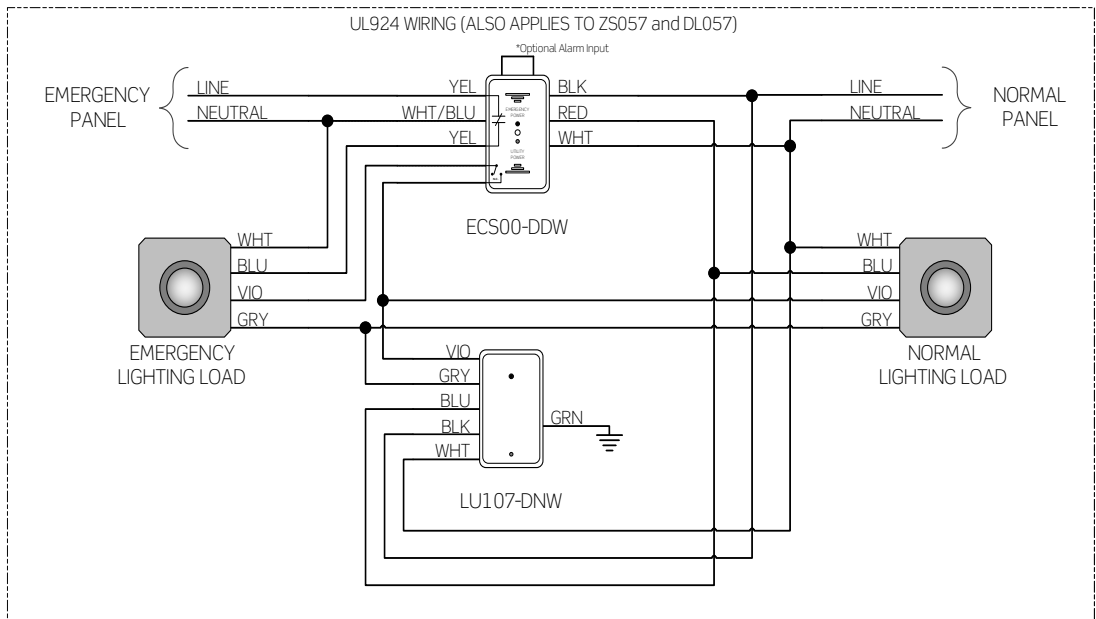
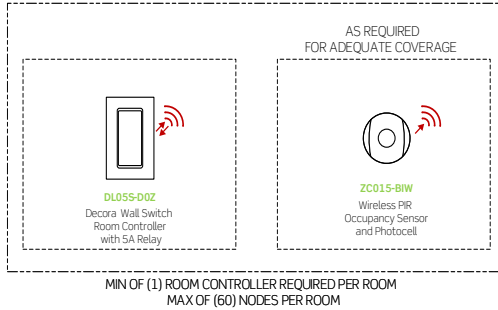

# Ordering Information



## Keypad Room Controllers

Cat. No.	Description
DLDNK-01W	Lumina RF Decora 1-Button multi-function BLE keypad with room controller and LED feedback functionality, 120-277VAC, 50/60Hz, White
DLDNK-02W	Lumina RF Decora 2-Button multi-function BLE keypad with room controller and LED feedback functionality, 120-277VAC, 50/60Hz, White
DLDNK-04W	Lumina RF Decora 4-Button multi-function BLE keypad with room controller and LED feedback functionality, 120-277VAC, 50/60Hz, White
DLDNK-08W	Lumina RF Decora 8-Button multi-function BLE keypad with room controller and LED feedback functionality, 120-277VAC, 50/60Hz, White

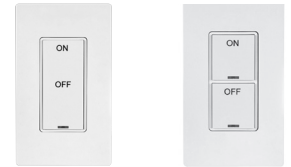

## Wireless Room Controllers

Cat. No.	Description
DL05S-D0Z	Decora Wireless Wall Switch Room Controller with 5A Relay, 120-277VAC, 50/60Hz, 5A Load, Color: White, Light Almond, Ivory
DL057-D0Z	Decora Wireless 0-10V Dimmer Room Controller with 5A Relay, 2.4GHz, 120-277VAC, 50/60Hz, 5A Load, Color: White, Light Almond, Ivory
DL057-30Z	Decora Wireless 0-10V Dimmer Room Controller with 5A Relay, 2.4GHz, 347VAC, 50/60Hz, 5A Load, Color: White, Light Almond, Ivory



## Wireless Load Control Devices

Cat. No.	Description
LU04P-1NW	Wireless 800W Phase Cut Dimming Power Pack
LU107-DNW	Wireless 10A 0-10V Dimming Power Pack
LU20S-DNW	Wireless 20A ON/OFF Switching Power Pack
ZS10S-D0Z	Decora Wireless Wall Switch, 120-277VAC, 50/60Hz, 10A Load, Available in White with Color Change Kit available for Ivory and Light Almond
ZS057-D0Z	Decora Wireless 0-10V Wall Dimmer, 2.4GHz, 120-277VAC, 50/60Hz, 8A Load, 0-10V Sinking, 50mA, Available in White with Color Change Kit available for Ivory and Light Almond
ZS057-30Z	Decora Wireless 0-10V Wall Dimmer, 2.4GHz, 347VAC, 50/60Hz, 4A Load, 0-10V Sinking, 50mA, Available in White with Color Change Kit available for Ivory and Light Almond
ZS057-ALZ	Decora Wireless 0-10V Low Voltage Wall Dimmer, 2.4GHz, 24VDC, 0-10V Sinking, 20mA, Available in White with Color Change Kit available for Ivory and Light Almond
ZSTLR-1HW	Zigbee Controlled Receptacle, bottom controlled



## Wireless Sensor & Photocell

Cat. No.	Description
ZC015-BIW	Wireless Occupancy Sensor & Photocell



# Service and Support



## During Every Step of the Process.

There is much more to making lighting more energy efficient than just installing a simple device or two. System design, product selection, installation and service: it all has to come together. That's where Leviton service and support options come in. We'll help you design your Lumina RF Wireless Room Control System and make the right product selections so you can create a solution that does exactly what you want it to do while saving electricity, meeting codes and standards, and even garnering rebates.

It all starts with the Leviton sales representative. Our lighting control specialists are here to support you every step of the way. They can perform on-site facility audits and suggest the best Lumina RF Wireless Room configuration to meet your needs and preferences.

## Exclusive Wealth of Resources

- **Exclusive Training**—contact your local Leviton representative to have a Lumina RF expert provide training in person or online exclusively for your team
- **Lumina RF Resource Library**—all of our data sheets, cookbooks, solution sheets and more in one easy-to-access place - visit [www.leviton.com/luminarf](http://www.leviton.com/luminarf)
- **Lumina RF Standalone App**—configure and control the entire Lumina RF Wireless Room Control System from the palm of your hand - download at [www.leviton.com/apps](http://www.leviton.com/apps)
- **ez-Learn™**—get Leviton smart from the comfort of your home or office with this exclusive 24/7 online training—go to [www.leviton.com/ezlearn](http://www.leviton.com/ezlearn)
- **Lighting control specialists** at your disposal
- **Field service engineers** for top-level support
- **Factory commissioning service**
- **Dedicated technical support** via phone at **800 959-6004**



### Leviton Manufacturing Co., Inc. Lighting & Controls

20497 SW Teton Avenue, Tualatin, OR 97062 tel 800-736-6682 tech line (6:00AM-4:00PM PT Monday-Friday) 800-954-6004

### Leviton Manufacturing Co., Inc. Global Headquarters

201 North Service Road, Melville, NY 11747-3138 tel 800-323-8920 tech line (8:00AM-10:00PM ET Mon-Fri, 9:00AM-7:00PM ET Sat, 9:00AM-5:00PM ET Sun) 800-824-3005

Visit our website at: [www.leviton.com/luminarf](http://www.leviton.com/luminarf)

©2023 Leviton Manufacturing Co. Inc. All rights reserved. Subject to change without notice.

LES-G-10387A/D23-aa  
REV APR 2023