

Single Pole (One location) or 3-Way (Multi-location) Decora® Manual-ON Occupancy Sensor

California Title 24 2005 Compliant

Cat. No. IPP15-1L

Incandescent: 1800W-15A @ 120V

Fluorescent: 1800VA-15A @ 120V

Supplemental: 1/2hp @ 120V

No Minimum Load Required

Compatible with incandescent lamps, electronic and magnetic low-voltage ballasts, electronic and magnetic ballasts, and fans.

INSTALLATION INSTRUCTIONS

WARNINGS AND CAUTIONS:

- To be installed and/or used in accordance with appropriate electrical codes and regulations.
- If you are unsure about any part of these instructions, consult a qualified electrician.
- Controlling a load in excess of the specified ratings will damage the unit and pose risk of fire, electric shock, personal injury or death. Check your load ratings to determine suitability for your application.
- Do not install this unit to control a receptacle.

WARNINGS AND CAUTIONS:

- The IPP15 Manual-On Occupancy Sensor is intended to replace a standard light switch.
- Do not touch the surface of the lens. Clean outer surface with a damp cloth only.
- Disconnect power at circuit breaker or fuse when servicing, installing or removing fixture.
- Use this device only with copper or copper clad wire. With aluminum wire use only devices marked CO/ALR or CU/AL.

Tools needed to install your Sensor:

Slotted/Phillips Screwdriver Electrical Tape Pliers
Pencil Cutters Ruler

DESCRIPTION

Leviton's Cat. No. IPP15-1L Manual-On Occupancy Sensor acts like a regular wall switch taking place of your existing wall switch. It has added benefit that if you forget to turn the light OFF, the lights will turn OFF automatically if motion is not detected within its coverage area. The Sensor is used to provide energy savings and convenience in a variety of residential applications including:

Bathrooms Basement Laundry Room
Garages Utility Rooms Dining Room
Hallways

The IPP15-1L, which features a Manual-ON operation, is California Title 24 2005 compliant. The unit turns off manually or in absence of motion according to the timeout selected. The unit installs in place of a single-pole or 3-way wall switch and fits in a standard wall box. The unit can be used for switching incandescent and fluorescent and low voltage lighting with electronic or magnetic ballasts.

The Sensor senses motion within its coverage area of 900 sq. ft. (83.6 m²) maximum and controls the connected lighting. The Sensor uses a small semiconductor heat detector that resides behind a multi-zone optical lens. This Fresnel lens establishes dozens of zones of detection. The sensor is sensitive to the heat emitted by the human body. In order to keep the lights ON, the source of heat must move from one zone of detection to another. The device is most effective in sensing motion across its field-of-view, and less effective sensing motion towards or away from its field-of-view (refer to Field-Of-View Diagrams). Obstructions such as furniture, windows, glass shower doors, etc... may prevent the sensor from detecting motion. Keep this in mind when selecting the installation location.

Note that the sensor responds to rapid changes in temperature, so care should be taken not to mount the device near a climate control source (i.e. radiators, air exchanges, and air conditioners). Hot or cold drafts will look like body motion to the device and will trigger it if the unit is mounted too close. It is recommended to mount the Sensor at least 6 ft. away from the climate control source. The device can be mounted in a single gang wall box.

In addition, it is also recommended NOT to mount the Sensor directly under a large light source. Large wattage bulbs (greater than 100W incandescent) give off a lot of heat and switching the bulb causes a temperature change that can be detected by the device. Mount the Sensor at least 6 ft. away from large bulbs. If it is necessary to mount the device closer, reduce the wattage of the bulb directly overhead.

INSTALLING YOUR SENSOR

NOTE: Use check boxes when Steps are completed.

Step 1 WARNING: TO AVOID FIRE, SHOCK, OR DEATH; TURN OFF POWER at circuit breaker or fuse and test that power is off before wiring!

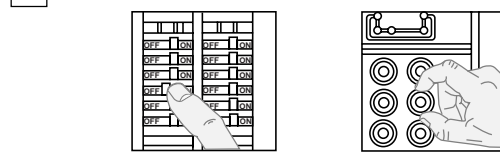

Step 2 Identifying your wiring application (most common):

NOTE: If the wiring in the wall box does not resemble this configuration, consult a qualified electrician.

Single Pole

- Line (Hot)
- Neutral
- Ground
- Load

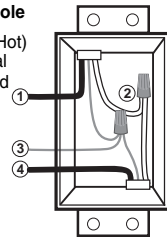

3-Way

- Line or Load (see important instruction below)
 - Neutral
 - Ground
 - First Traveler - note color
 - Second Traveler - note color.
- NOTE: For matching switch remote w/LED installation, the First Traveler becomes Line Hot.

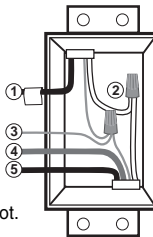

Step 3 Preparing and connecting wires:

This sensor can be wired using side wire terminal screws or through backwire openings. Choose appropriate wire stripping specifications accordingly.

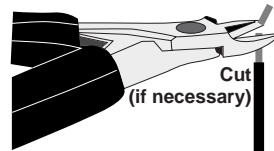

Strip Gauge
(measure bare wire here)

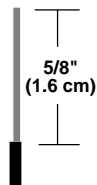

Side Wire Connection

Side wire terminals accept #14 AWG solid wire copper only.

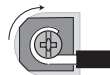

Back Wire (either hole may be used)

Back wire openings use #14-12 AWG solid wire copper only.



Step 3 cont'd

- Make sure that the ends of the wires from the wall box are straight (cut if necessary).
- Remove insulation from each wire in the wall box as shown.
- For Single-Pole Application, go to Step 4a.
- For 3-Way Coordinating Remote (no LED) Application, go to Step 4b.
- For 3-Way Matching Remote (with LED) or IPP0R Sensor Remote Application, go to Step 4c.

Step 4a Installing your Sensor – Single-Pole Wiring Application:

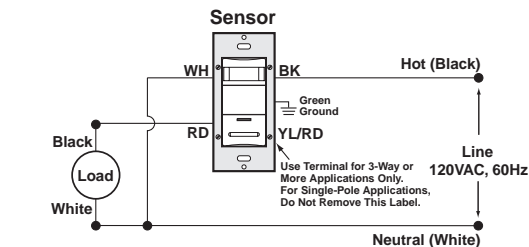
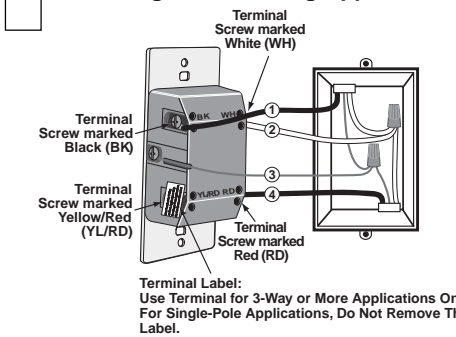

WIRING SENSOR:

Connect wires per WIRING DIAGRAM as follows:

- Green or bare copper wire in wall box to Green terminal screw.
 - Line Hot wall box wire to terminal screw marked "BK".
 - Load wall box wire to terminal screw marked "RD".
 - Line Neutral wall box wire to terminal screw marked "WH".
 - Sensor terminal screw marked "YL/RD" should have Red insulation label affixed.
- NOTE: If insulating label is not affixed to terminal screw marked "YL/RD", use electrical tape to cover.
- Proceed to Step 5.

Step 4b 3-Way Wiring with Vizia™ Coordinating Remote (no LED) Application:

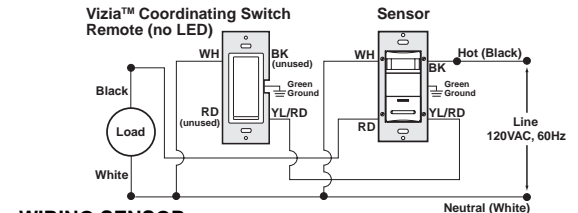
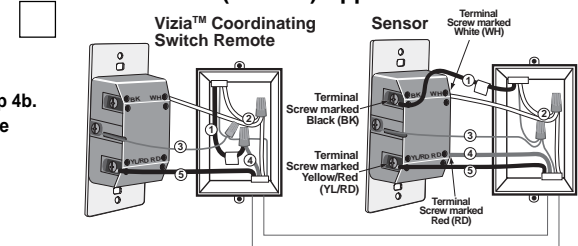

WIRING SENSOR:

Connect wires per WIRING DIAGRAM as follows:

NOTE: The sensor must be installed in a wall box that has a Line Hot connection.
NOTE: Maximum wire length from sensor to all installed remotes cannot exceed 300 ft (90 m).

- Green or bare copper wire in wall box to Green terminal screw.
- Line Hot (common) wall box wire identified (tagged) when removing old switch to terminal screw marked "BK".
- First Traveler wall box wire to terminal screw marked "RD" (note wire color).
- Remove Red insulating label from terminal screw marked "YL/RD".
- Second Traveler wall box wire to terminal screw marked "YL/RD" (note wire color). This traveler from the sensor must go to the terminal screw on the remote marked "YL/RD".
- Line Neutral wall box wire to terminal screw marked "WH".

WIRING COORDINATING REMOTE:

Connect wires per WIRING DIAGRAM as follows:

NOTE: "BK" and "RD" terminals on coordinating remote are unused. Tighten both screws.
NOTE: Maximum wire length from sensor to last remote is 300 ft (90 m).

- Green or bare copper wire in wall box to Green terminal screw.
- Load wall box wire identified (tagged) when removing old switch to First Traveler (note color as above).
- Second Traveler wall box wire (note color as above) to terminal screw marked "YL/RD". This traveler from the remote must go to the terminal screw on the sensor marked "YL/RD".
- Remove White insulating label from terminal screw marked "WH".
- Line Neutral wall box wire to terminal screw marked "WH".
- Proceed to Step 5.

Step 4c 3-Way Wiring with Sensor Remote or Vizia™ Matching Remote (w/LED)

Application:

NOTE: IPP0R sensor remote is depicted.

IPP0R/VZ0SR-1L Remote

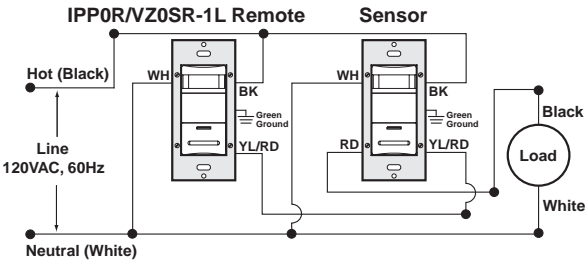
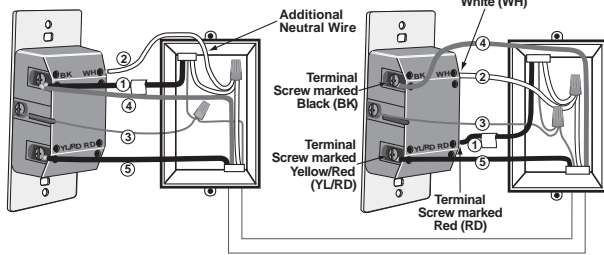

NOTE: The sensor **must** be installed in a wall box that has a Load connection. The remote **must** be installed in a wall box with a Line Hot connection and a Neutral connection. A Neutral wire to the remote needs to be added as shown. If you are unsure about any part of these instructions, consult a qualified electrician.

NOTE: Maximum wire length from sensor to all installed remotes cannot exceed 300 ft (90 m).

WIRING REMOTE

(wall box with Line Hot connection):

Connect wires per WIRING DIAGRAM as follows:

- Green or bare copper wire in wall box to Green terminal screw.
- Line Hot (common) wall box wire identified (tagged) when removing old switch and First Traveler to sensor terminal screw marked "BK".
- Second Traveler wall box wire from sensor to remote terminal screw marked "YL/RD" (note wire color). This traveler from the remote must go to the terminal screw on the sensor marked "YL/RD".
- Line Neutral wall box wire to remote terminal screw marked "WH".

WIRING SENSOR (wall box with Load connection):

Connect wires per WIRING DIAGRAM as follows:

- Green or bare copper wire in wall box to Green terminal screw.
- Load wall box wire identified (tagged) when removing old switch to terminal screw marked "RD".
- First Traveler Line Hot to terminal screw marked "BK".
- Remove Red insulating label from terminal screw marked "YL/RD".
- Second Traveler wall box wire (note color as above) to terminal screw marked "YL/RD". This traveler from the sensor must go to the terminal screw on the remote marked "YL/RD".
- Line Neutral wall box wire to remote terminal screw marked "WH".
- Proceed to Step 5.

Step 5 Testing your Sensor prior to completely mounting in wall box:

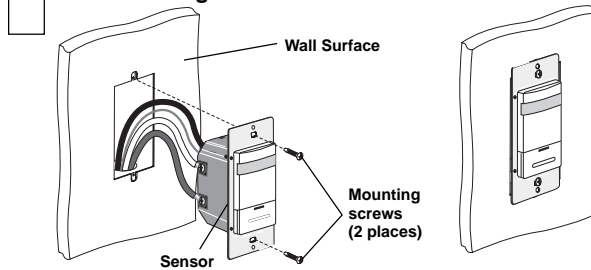

NOTE: Dress wires with a bend as shown in diagram to relieve stress when mounting device.

- Position all wires to provide room in outlet wall box for device.
- Ensure that the word "TOP" is facing up on the device strap.
- Partially secure device using long mounting screws provided.
- Restore power at circuit breaker or fuse.
- Perform the adjustments for the time-out and blinder settings (refer to Time Delay and Blinders section).

If necessary, adjust the range control and the blinders to stop any unwanted activation of the lights.

NOTE: To avoid PERMANENT DAMAGE to the unit, be careful NOT TO OVERTURN the control knobs or levers when setting the Sensor. The controls can be accessed by removing the wallplate (if applicable) and control panel cover (refer to Sensor Features Diagram). Use a small straight blade screwdriver to adjust knobs and blinder levers.

NOTE: DO NOT press in on blinder levers or use excessive force (refer to Sensor Features Diagram).

- Attach the Control Panel cover when the desired settings are complete.

If lights still do not turn ON, refer to the TROUBLESHOOTING section.

BLINDERS: The blinders can narrow the field-of-view of the device to prevent unwanted activation from traffic in adjacent space. There are two blinders, and each operate independently. To operate the blinders, use a small screwdriver to move the blinder adjustment levers toward or away from the center of the device. The blinder levers are found above the control knobs and below the text 'BLINDERS' on the control panel. With both levers moved fully towards the center, the field-of-view is narrowed to 32°. With both levers moved fully away from the center, the field-of-view is at a maximum 180° (refer to Sensor Features Diagram).

TIME-DELAY: Cat. No. IPP15 will turn lights ON only when the switch is manually activated. When motion is no longer detected, the Sensor Unit will wait the selected amount of time and then turn the lights OFF. This wait time is called 'time-out'. The "time-out" is selected from four (4) preset values. Pointing the arrow at one of the markings on the face chooses the value of time. The following selections are available:

Face Marking	Value of Time
(/) Slash Mark	30 second fixed time-out used for performing a walk-test.
1	5 minute time-out
2	15 minute time-out
3	30 minute time-out

The "time-out" is factory preset to thirty (30) minutes. Refer to Sensor Features Diagram.

NOTE: All time durations mentioned in the instructions are approximate within 10 seconds.

Manual ON: The lights need to be manually turned ON by the push-button, and will turn OFF with the absence of motion or can be manually turned OFF.

RANGE: To decrease detection range and sensitivity, rotate the knob counter-clockwise (refer to Sensors Feature Diagram). The detection range can be adjusted from 100% down to 36%.

Sensor Features Diagram

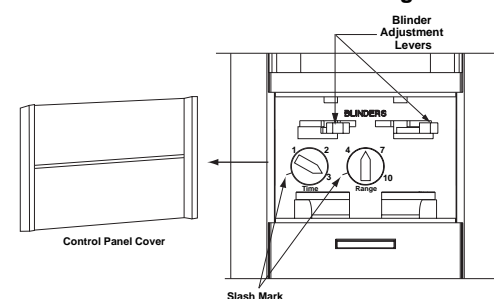

NOTE: "Time" and "Range" knobs are shown in factory preset positions.

Field-of-View (Horizontal)

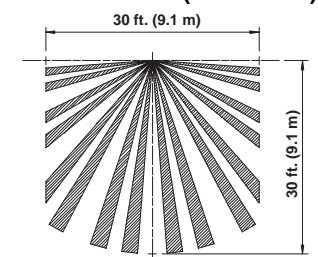

Side (Vertical) Field-of-View

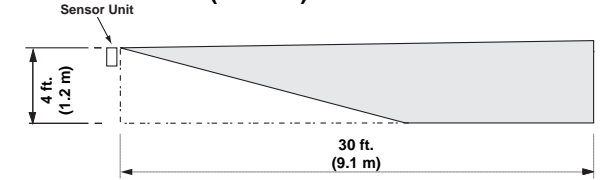

Step 6 Sensor and Wallplate Mounting:

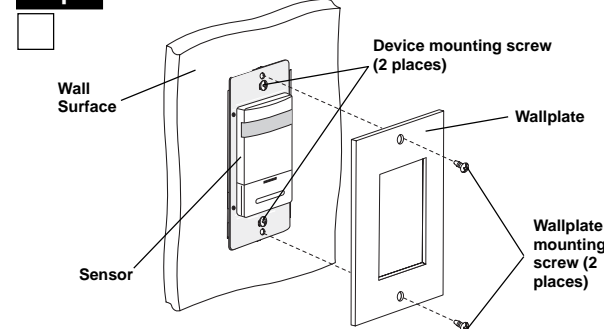

- Secure device by firmly tightening mounting screws.
- Install Decora® style wallplate (sold separately).

OPERATION

Cat. No. IPP15 has a push-button switch that will toggle the lights ON and OFF (refer to diagram). The lights will not turn ON automatically with occupancy. If the lights are OFF, the lights will turn ON when the button is pressed, and remain ON in the presence of motion. The Sensor will turn the lights OFF either in the absence of motion or when the button is pressed. If motion is detected within 30 seconds after the lights have turned OFF due to absence of motion, the lights will turn back ON. If 30 seconds expires when lights have turned OFF due to absence of motion, the lights will then have to be turned ON manually.

NOTE: This feature does not apply when the lights are manually turned off. NOTE: The Motion Indicator LED will blink every 2 seconds while motion is detected.

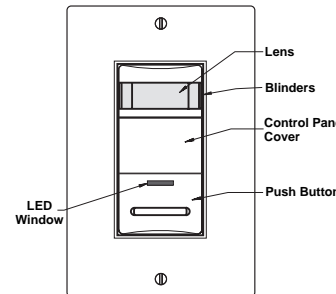

TROUBLESHOOTING

- If there is no response from the unit and the LED never blinks or the push button does not activate the lights 1 1/2 minutes after power is applied, then uninstall device and verify wiring (Step 4).
- If the lights constantly stay ON, even when the room is unoccupied:
 - Check the Time setting. See how this time compares to how long the lights stay ON.
 - Try lowering the Range Control. Rotate the knob counter-clockwise about 30°.
 - If the problem persists, try reducing again. Note: Do Not reduce so much that Cat. No. IPP15-1L cannot see normal occupancy.
 - Be sure to use the Blinders to block any unwanted hallway traffic.
 - Check for reflected heat/motion as Sensor Unit may be seeing motion through a window.
 - Check for adjacent HVAC and/or heater ducts.

PRODUCT INFORMATION

- For technical assistance contact us at 1-800-824-3005
- Visit our website at www.leviton.com

FCC COMPLIANCE STATEMENT

This equipment has been tested and found to comply with the limits for a Class B Digital Device, pursuant to Part 15 of the FCC Rules. These limits are designed to provide reasonable protection against harmful interference in a residential installation. This equipment generates, uses, and can radiate radio frequency energy and, if not installed and used in accordance with the instructions, may cause harmful interference to radio communications. However, there is no guarantee that interference will not occur in a particular installation. If this equipment does cause harmful interference to radio or television reception, which can be determined by turning the equipment OFF an ON, the user is encouraged to try to correct the interference by one or more of the following measures:

- Reorient or relocate the receiving Antenna.
- Increase the separation between the equipment and the receiver.
- Connect the equipment into an outlet on a circuit different from that to which the receiver is connected.
- Consult the dealer or an experienced radio/tv technician for help.

LIMITED 5 YEAR WARRANTY AND EXCLUSIONS

Leviton warrants to the original consumer purchaser and not for the benefit of anyone else that this product at the time of its sale by Leviton is free of defects in materials and workmanship under normal and proper use for five years from the purchase date. Leviton's only obligation is to correct such defects by repair or replacement, at its option, if within such five year period the product is returned prepaid, with proof of purchase date, and a description of the problem to Leviton Manufacturing Co., Inc., Att: Quality Assurance Department, 59-25 Little Neck Parkway, Little Neck, New York 11362-2591. This warranty excludes and there is disclaimed liability for labor for removal of this product or reinstallation. This warranty is void if this product is installed improperly or in an improper environment, overloaded, misused, opened, abused, or altered in any manner, or is not used under normal operating conditions or not in accordance with any labels or instructions. There are no other or implied warranties of any kind, including merchantability and fitness for a particular purpose, but if any implied warranty is required by the applicable jurisdiction, the duration of any such implied warranty, including merchantability and fitness for a particular purpose, is limited to five years. Leviton is not liable for incidental, indirect, special, or consequential damages, including without limitation, damage to, or loss of use of, any equipment, lost sales or profits or delay or failure to perform this warranty obligation. The remedies provided herein are the exclusive remedies under this warranty, whether based on contract, tort or otherwise.